

Find more ideas here.

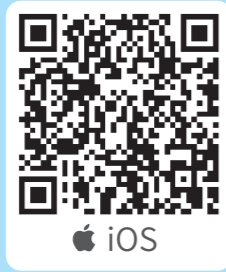

APP Download



What is STEAM?

STEAM stands for science, technology, engineering, mathematics and art. STEAM Education aims at cultivating children's comprehensive scientific thinking and abilities and emphasizing the interdisciplinary integration. It is very popular in the United States, Germany, the United Kingdom, Finland and other countries.

PBL (Project-based Learning) The Main Teaching Mode of STEAM

Project-based learning is a teaching and learning method that takes children as the center to design and implement projects, thereby promoting children's learning effects. Within a certain period of time, the child chooses, plans, proposes a project idea, and solves practical problems through various forms such as display.

Compared with traditional learning methods, project-based learning can effectively improve children's practical thinking and problem-solving abilities. The goal of project-based learning is to enable children to master subject knowledge more efficiently through practical methods that combine with reality, and to cultivate children's social and emotional skills in the process.

Makerzoid Robot Lab

As the leader of STEAM education, Makerzoid adopts interesting PLB guidance, so that children can enjoy valuable STEAM courses at home to learn while playing.

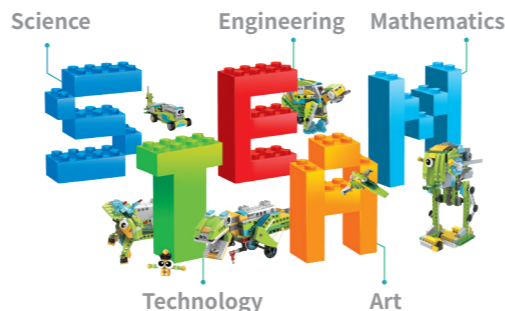

CATALOG

Chapter 1 Basic Knowledge

1.1 APP Instruction	001
1.2 Size: 1:1 Reference List	002
1.3 Basic Knowledge of Robot Parts	003
1.4 Precautions	005
1.5 Disassembly Skills	006

Chapter 2 Assembly Guide

2.1 Elasticity	007
Elastic Car	007
Elastic Pull Car	011
2.2 Inertia	017
Mini Inertia Car	017

2.3 Gravity	021
Tumbler	021
2.4 Lever	027
Jack	027
2.5 Gyro	033
Trigger Gyro	033
Grip Gyro	039
2.6 Hand Fan	043
2.7 Spinning YL-Man	048

Chapter 3 Robot Parts List	055
-----------------------------------	-----

Chapter 4 Product Details	056
----------------------------------	-----

Log in to the APP for more tutorials.

1.1 APP Instruction

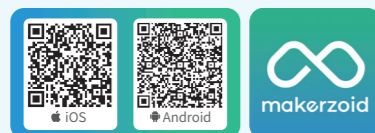

APP Download

APP icon

① Scan the QR Code

② APP store-search
"makerzoid"
IOS

② APP store-search
"makerzoid"
Android

① APP Download

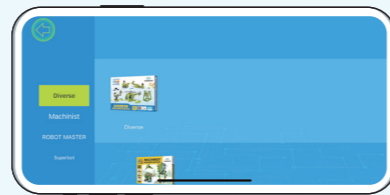

The APP includes different robot kits, you can choose the kit you have purchased

② Choose the Robot Kit

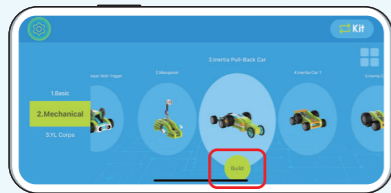

It teaches you how to build and control (should be connected to the host controller first) a robot

③ Build and Control the Robot



Video tutorials

1.2 1:1 Size Reference List

Shaft

2 (1x2)=2

3 (1x3)=3

4 (1x4)=4

5 (1x5)=5

6 (1x6)=6

7 (1x7)=7

8 (1x8)=8

10 (1x10)=10

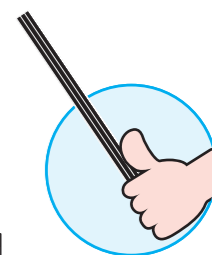

Plate

1x2

1x6

1x4

1x12

NOTICE

When you receive the product, please first read the contents of the parts list carefully, understand the shapes of various parts, and check the actual number of parts according to the list. After carefully watching these parts, the tutorials become much easier to understand. (Due to the need for production batches or display, the color of the parts you see in the illustrations may be different from the actual ones. Please distinguish different parts according to the shape. If you find any missing parts, please contact customer service.)

1.3 Basic Knowledge of Robot Parts

1.The Unit Size

One unit equals to eight millimeters. Generally the width, height, length of the part and the unit size are integer multiples.

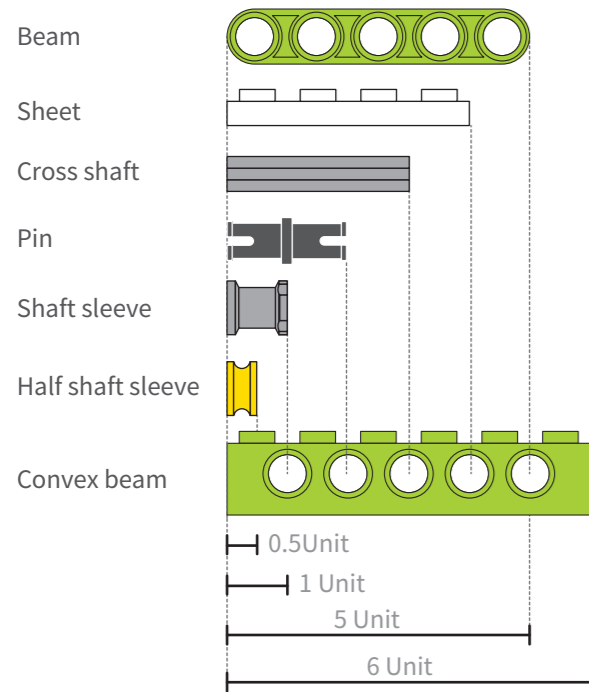

2.The Height of the Beam and the Hamburger Structure

The height of the beam and brick

The height of beam (or brick) = 1.2 unit = 9.6mm
 The height of a beam (or brick) equals to 3 sheets, so the height of each sheet is 0.4 unit, equals to 3.2mm.

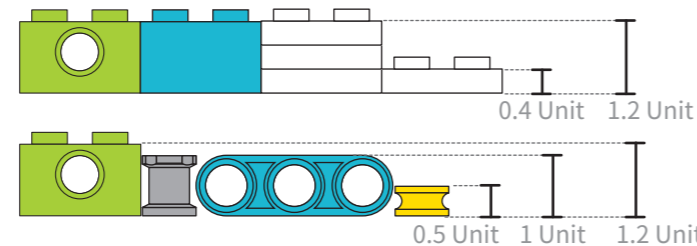

Hamburger Structure

The height of of two beams (or two bricks) and two sheets is 3.2 unit, the distance between two holes is 2 unit, simply understand as "2 thick+2 thin" (the two sheets should be put in the middle).
 The distance between the two holes of two beams (or bricks) is 1.2 unit, the height of two sheets is 0.8 unit, altogether is 2 unit.

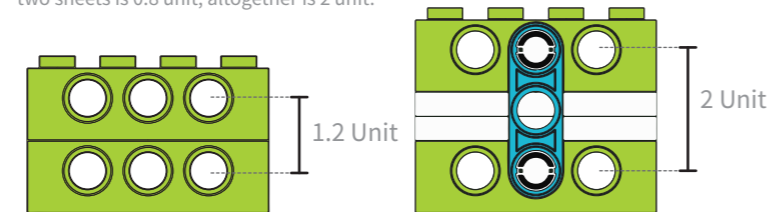

3.The Difference Between Pins

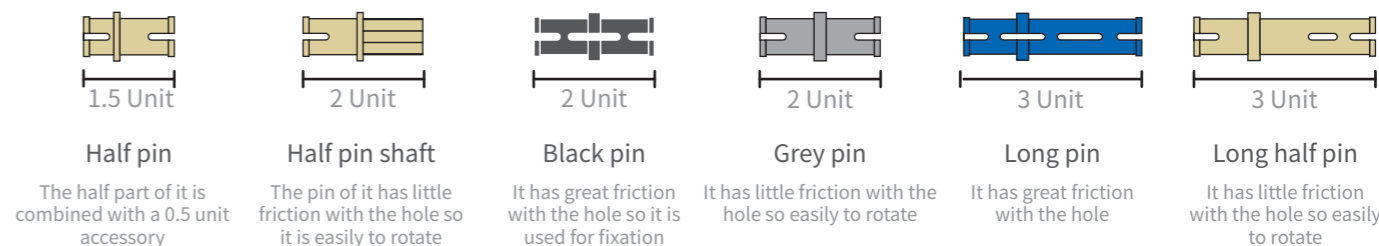

4.Use skills

Interlock

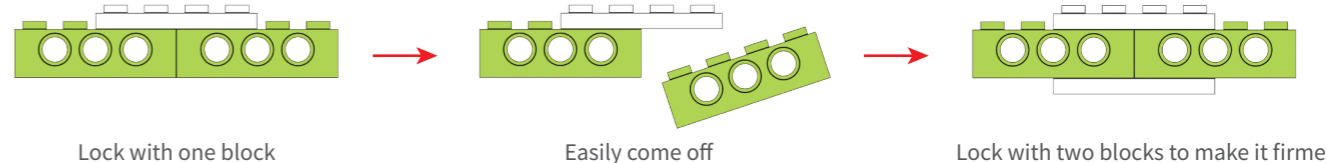

Two points determine a straight line



1.4 Precautions

The 4 most important points to read this manual

Firm Bricks

Make sure the building steps and connect all the bricks firmly. A small gap can easily hinder the complete set of actions.

Moveable Shaft

The shaft determines of the rotation of the object. Make sure not to let anything block it, and do not continue to rotate when it is blocked or stuck.

Unlimited Creativity

The number of blocks in each robot is not absolute, and children can replace it flexibly. For example, 8-shaft can be replaced with 10-shaft, and the building steps of the robot are also not constant. Children can also build the same robot in their own way.

Be Patient

Please read each step carefully before building the robot to ensure that it is built strictly in accordance with the diagrams in this book. It doesn't matter if you fail, keep going.

How to keep a brick-thick length for the connected object on the shaft?

Put the connecting object on the lower end of the shaft sleeve so that the shaft sleeve exposes a little length.

1

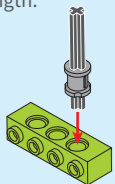

Place a brick hole face up on the table, align the exposed part of the shaft sleeve with the brick hole, and insert it down until the shaft sleeve touches the tabletop.

2

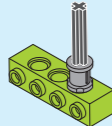

Pull out the shaft sleeve from the brick hole. At this time, the connecting object on the shaft sleeve is exactly the thickness of a brick from the bottom of the shaft sleeve.

3

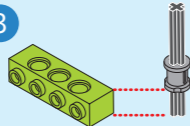

(Tip: How to make a wider distance? Build more bricks until it is thick enough, then the next step is the same as above.)

How to pass the rubber band through the brick hole?

Use your thumb and index finger to pinch one end of the rubber band into a small ring. Pass this small ring through the brick hole until you can catch the rubber band from the other end.

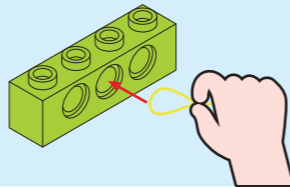

1.5 Disassembly Skills

The function of the splitter is to use the principle of leverage to dismantle parts, which is easy to use and quick to disassemble.

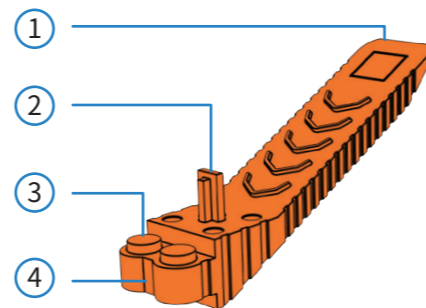

Don't bite the blocks.



Detach the blocks

As shown in Figure 1, the blocks are tightly attached. You can hold a hole brick with two hands, press down at the same time and then pull it out. You will find that the lower block is separated from the other block.

Figure1

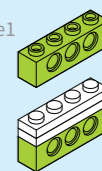
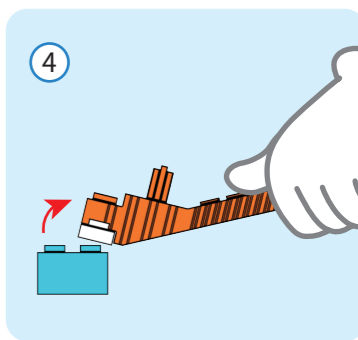
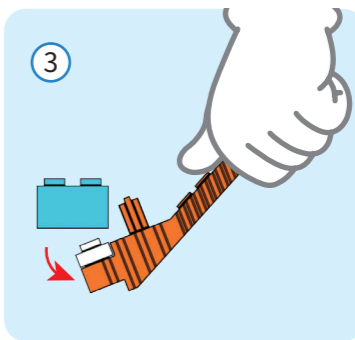
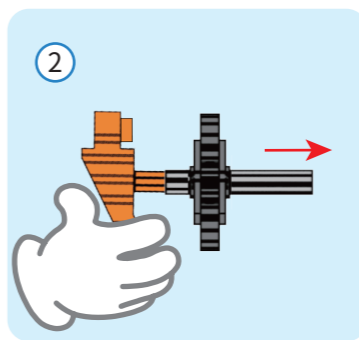
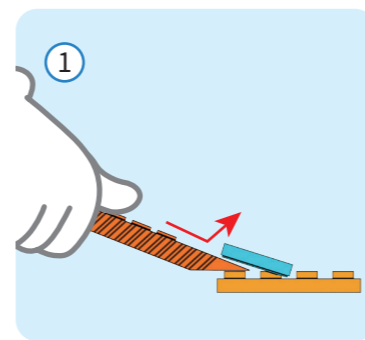
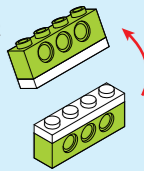
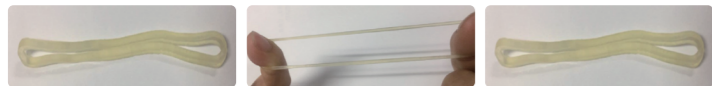

Figure2



2.1 Elasticity

The force generated by the elastic deformation of an object is called elastic force. After the object is deformed by force, if the external force disappears and the object can return to its original shape, such deformation is called elastic deformation.



Original Shape

Deformation

Recover When External Force Disappears

The force generated by the elastic deformation of an object is called elastic force. After the object is deformed by force, if the external force disappears and the object can return to its original shape, such deformation is called elastic deformation.



Original Shape

Deformation

Keep the Same When External Force Disappears

Think together:

What is the relationship between the magnitude of elasticity and the degree of deformation? Find out the answer in the process of playing the car.

Elastic Car

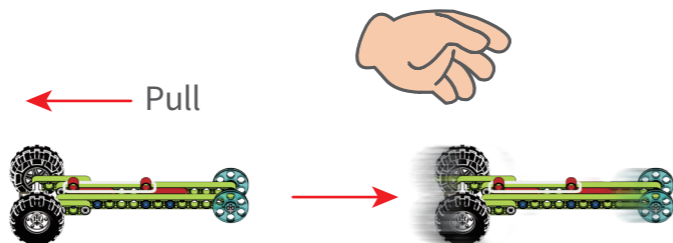
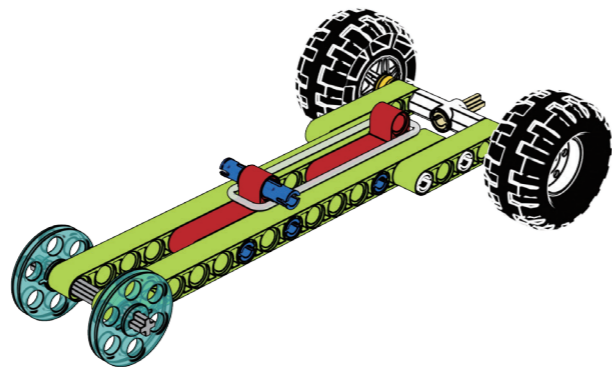

01

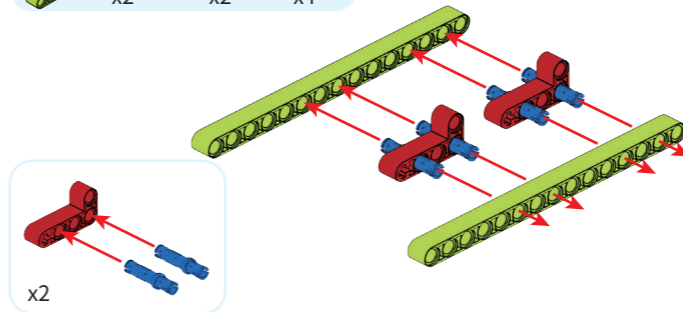
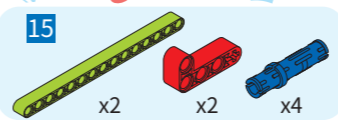

03

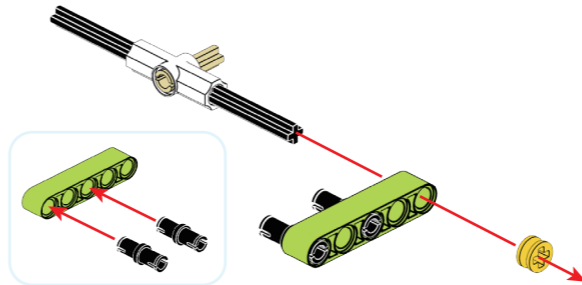
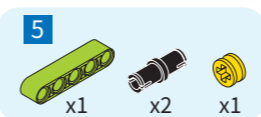

02

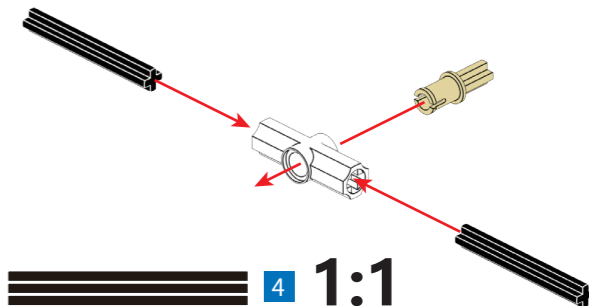
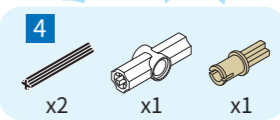

04

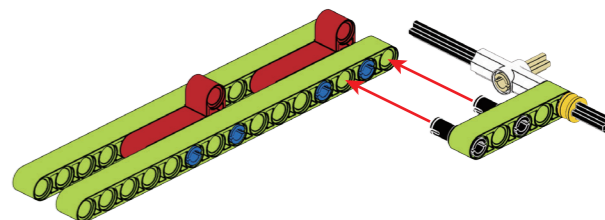

05

5

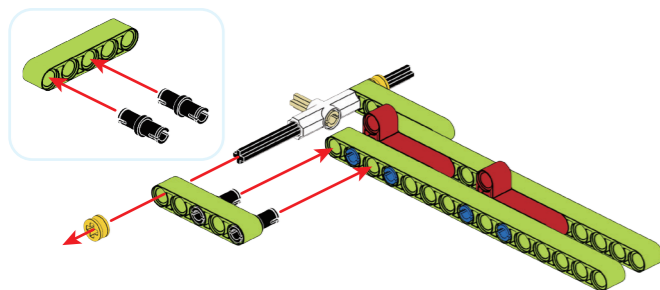
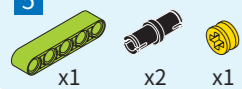

06

5

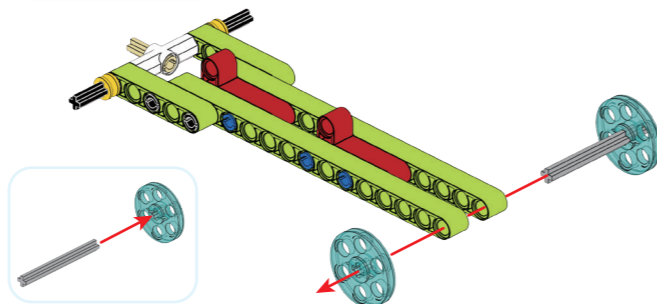
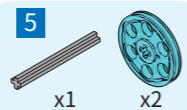

07

5

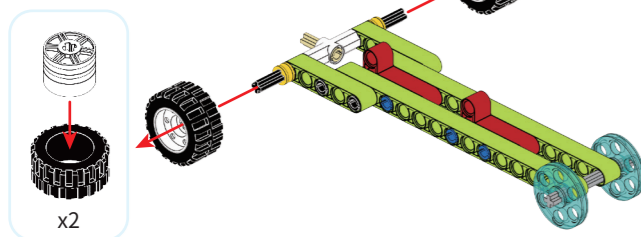
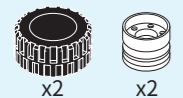

08

5

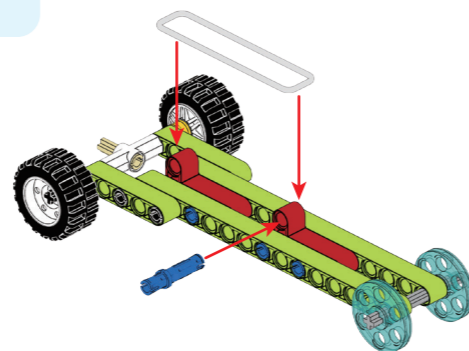
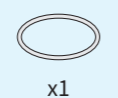

Car Race Game

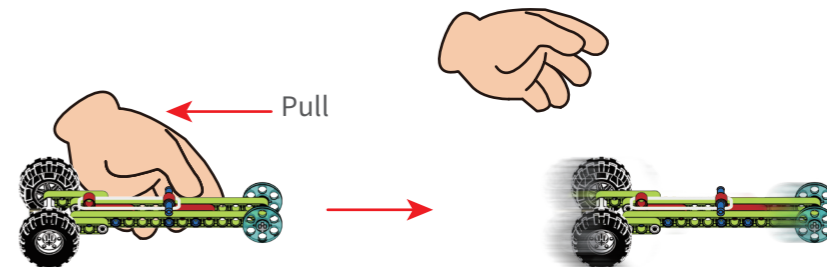
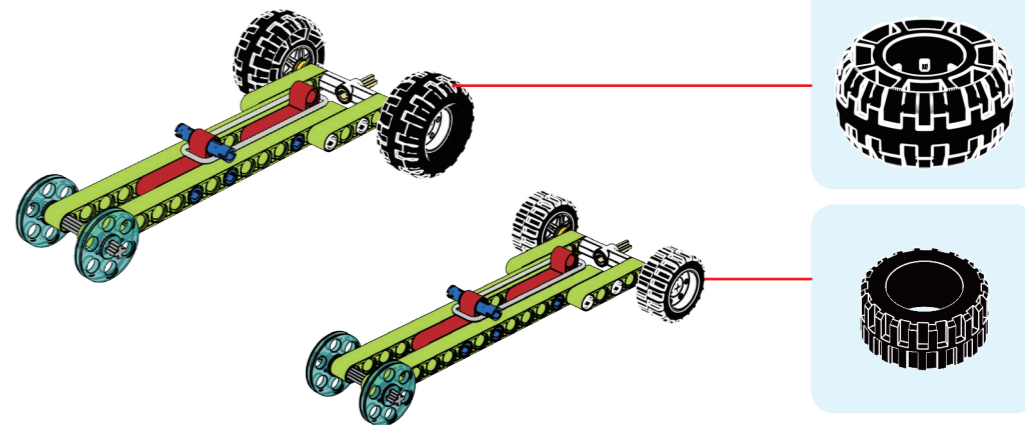

1 Fasten the rubber band (do not loosen it) and pull the car back.

2 Release the elastic car, the elastic force of the rubber band makes the car move forward.

Elastic Pull Car

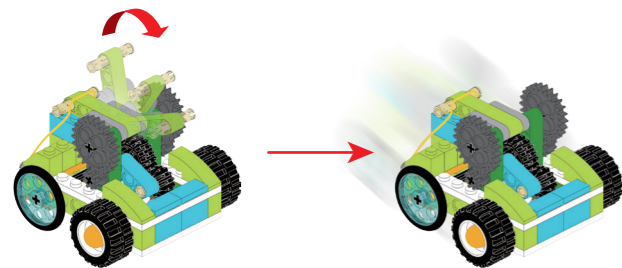
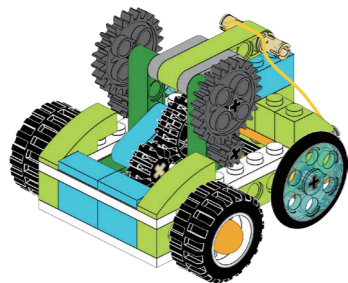

01

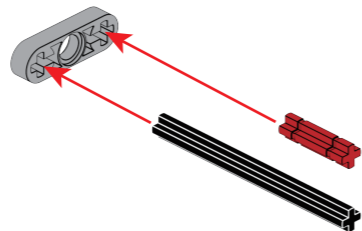
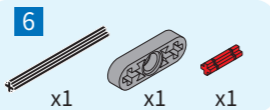

02

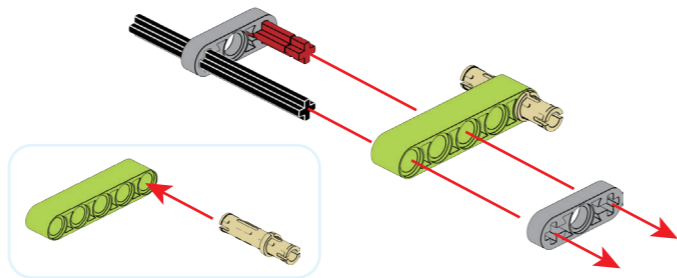
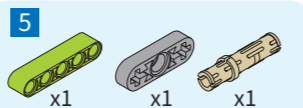

03

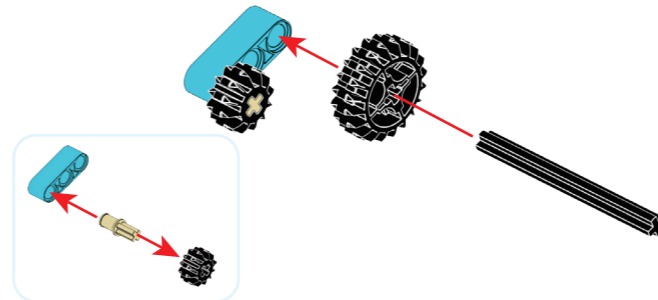

05

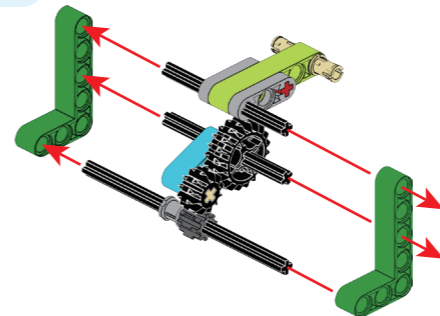
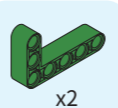

04

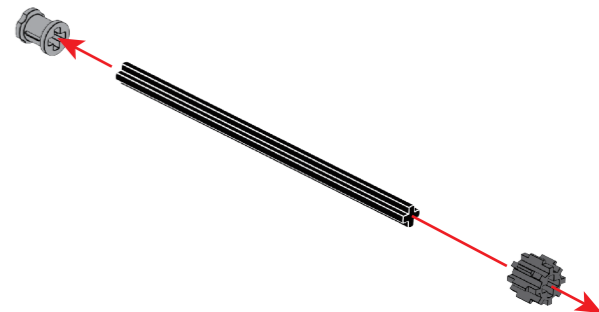
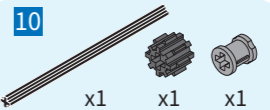

06

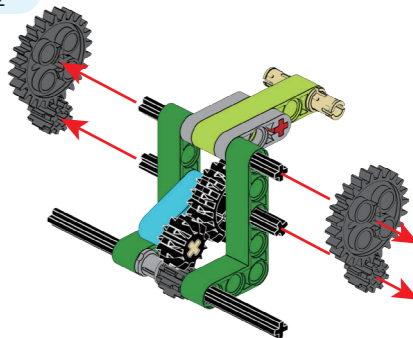
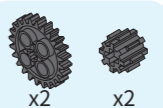

07

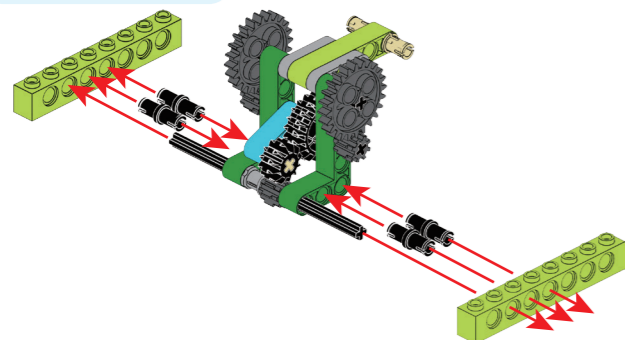
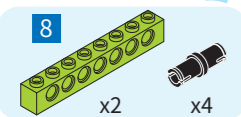

08

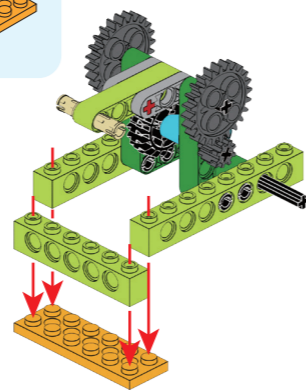
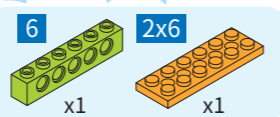

11

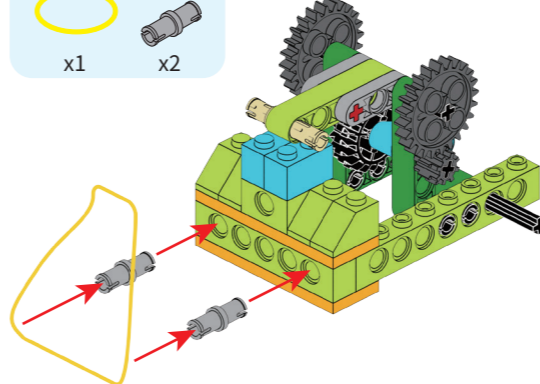
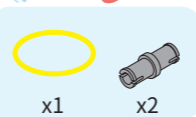

12

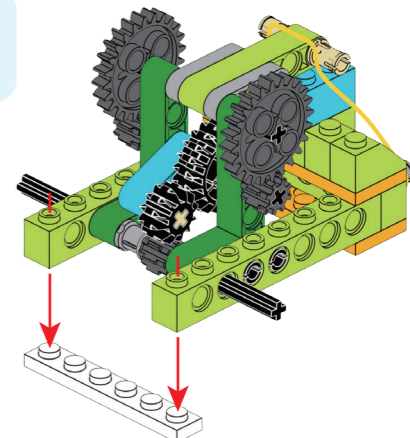
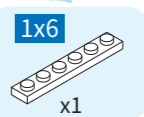

09

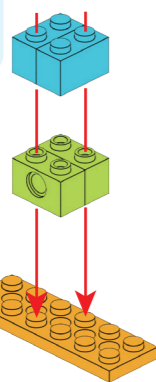
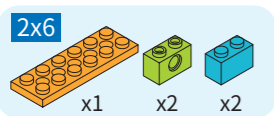

10

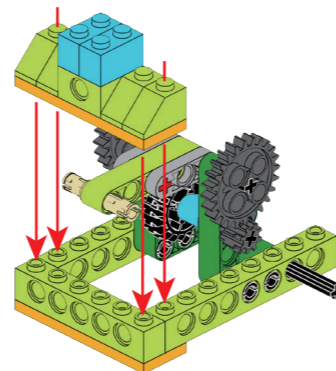
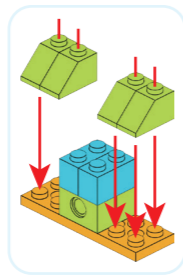

13

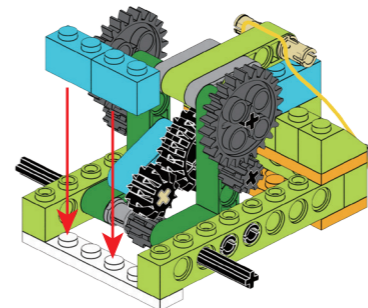

14

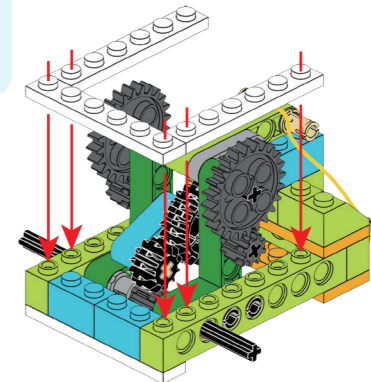
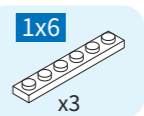

15



x2

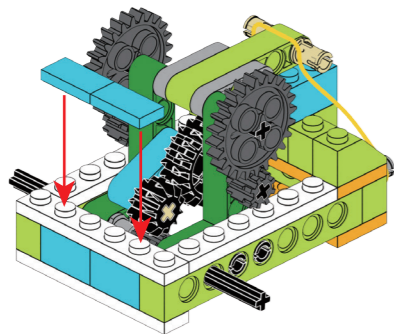

16



x2

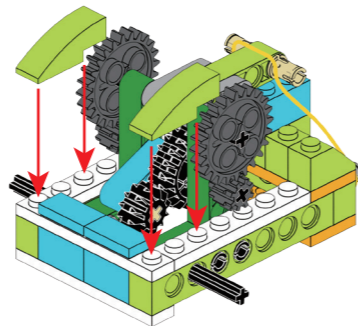

19



x2

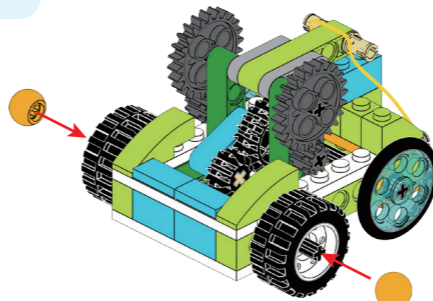

20

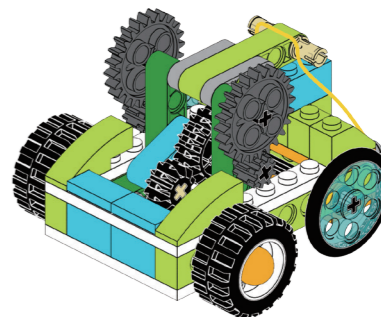

17

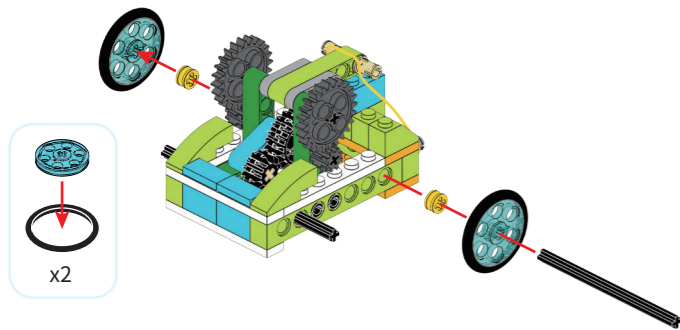
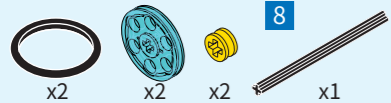

18

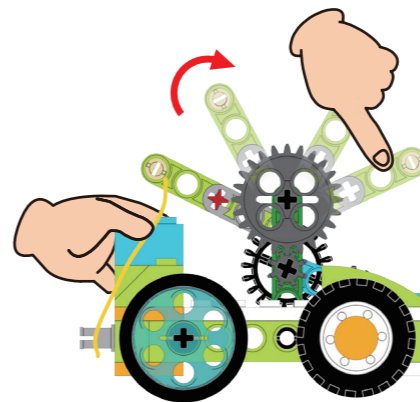
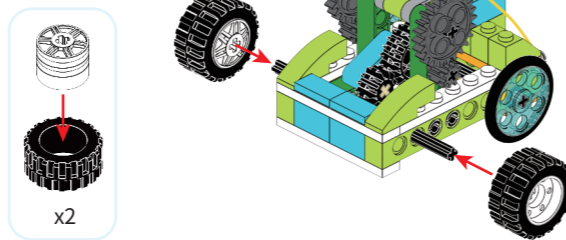
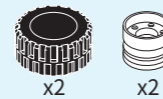

1 Hold down the car, pull the trigger back, the rubber band is stretched.

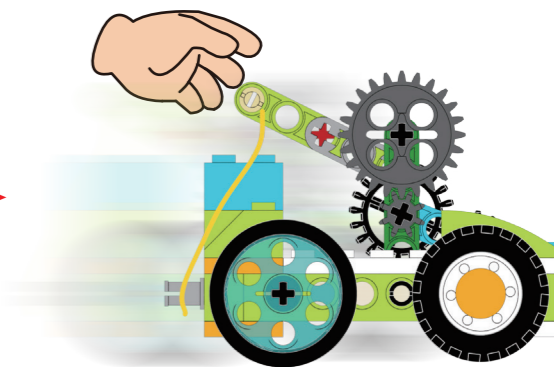

2 When the trigger is released, the elastic force of the rubber band moves the car forward.

2.2 Inertia

The property of an object in a static state or a state of direct motion at a constant speed is called inertia.

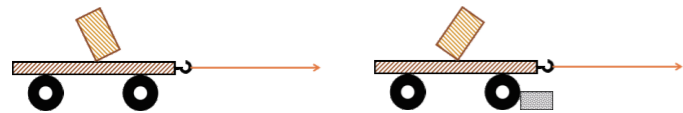

When the car is suddenly pulled, the block falls backward due to inertia.

When the car stops suddenly, the block falls backward due to inertia.

When the driver brakes suddenly, people will fall forward due to inertia, so you must remember to fasten the seat belt when riding in a car.



Think together:
What is the magnitude of inertia related to? Find out the answer in the process of playing the car.

Mini Inertia Car

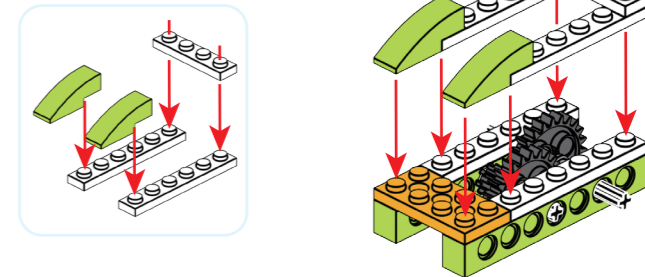
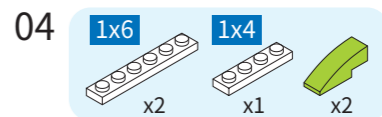
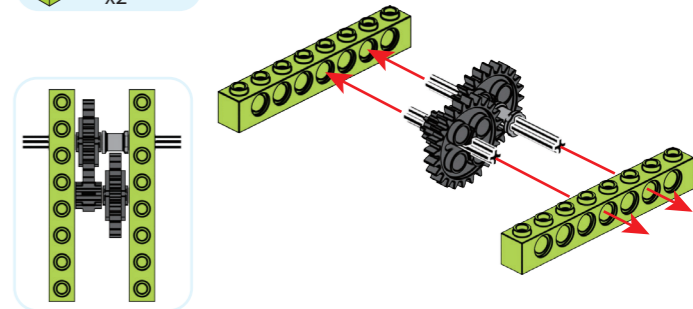
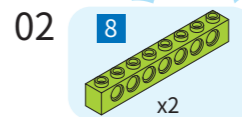
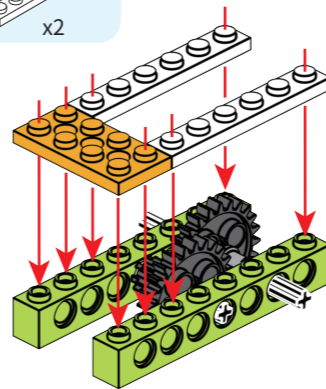
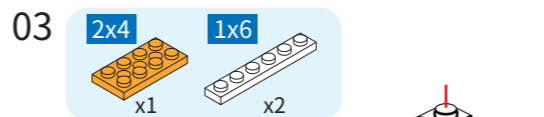
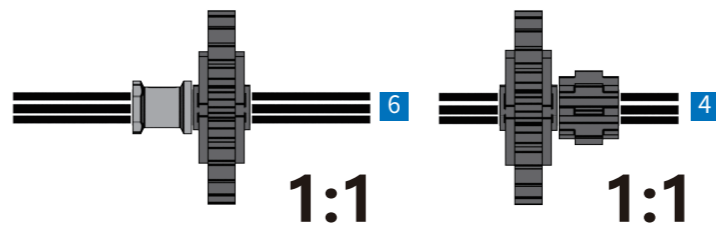
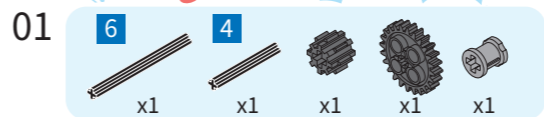
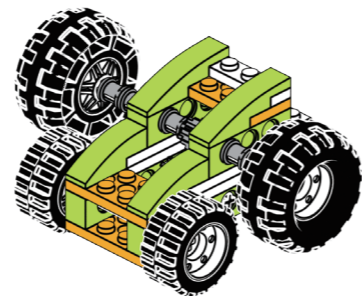

05

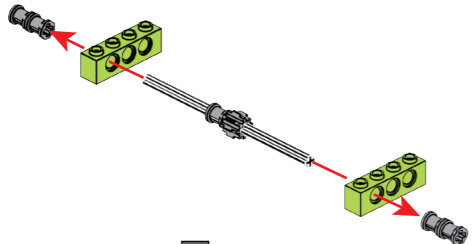
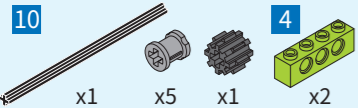

06

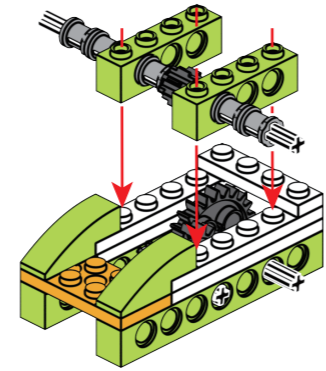

07

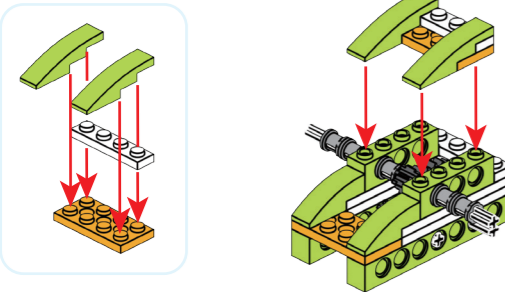
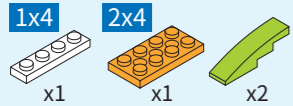

08

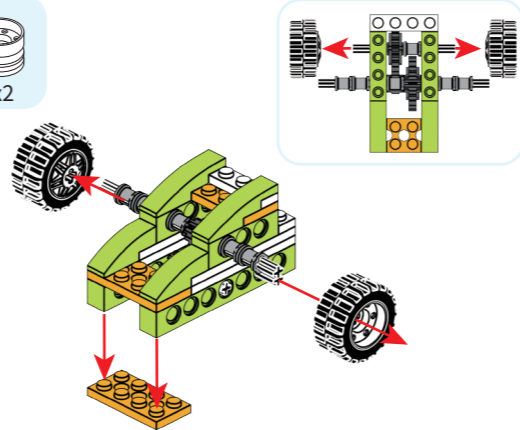
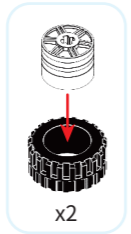
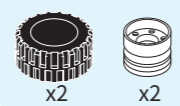

09

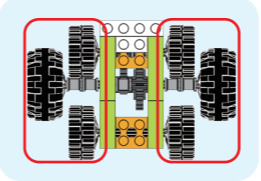
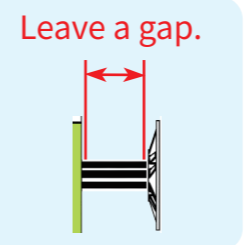
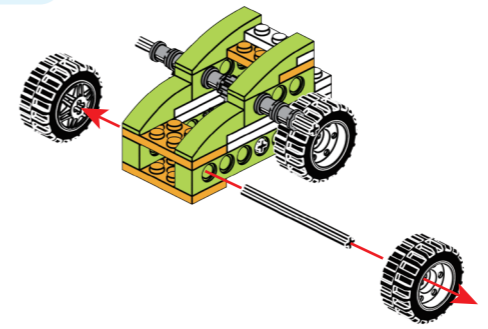
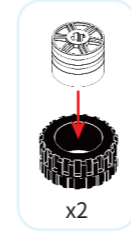
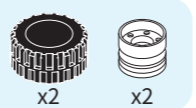

10

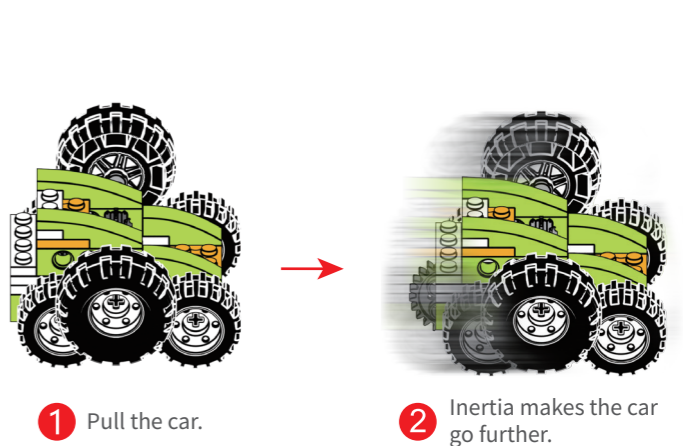
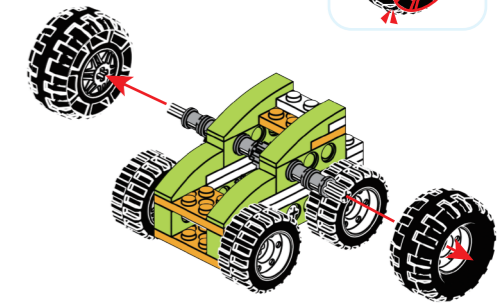
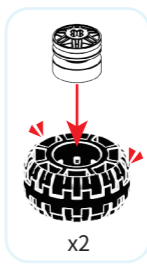
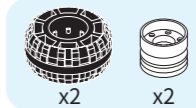

2.3 Gravity

Why do leaves, raindrops and people after high jumping fall to the ground?



This is because the earth is like a big magnet, attracting everything to the ground. The earth's attraction to objects is called gravity.

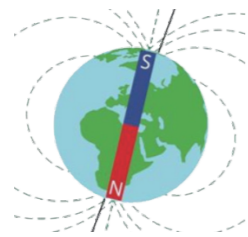

Think together:
What is the magnitude of gravity related to? Find out the answer while playing.

Tumbler

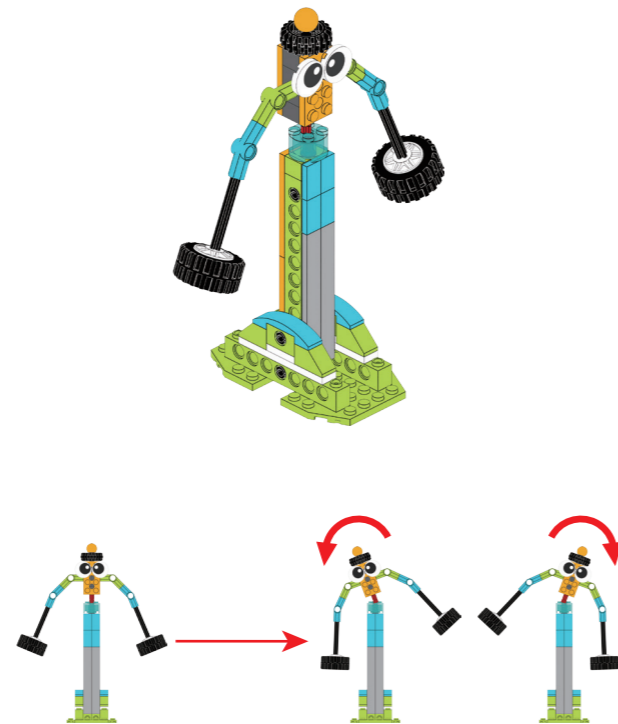

01

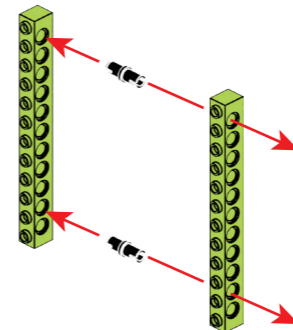
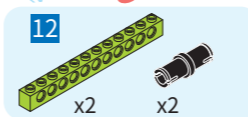

03

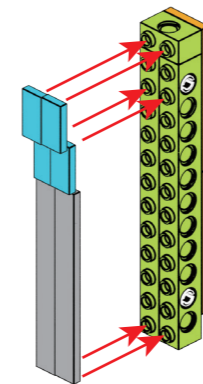
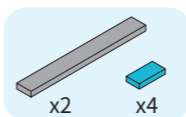

02

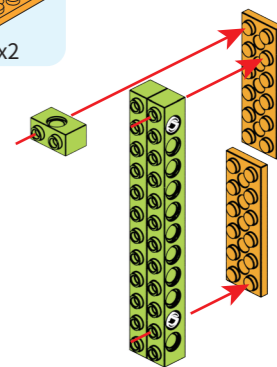
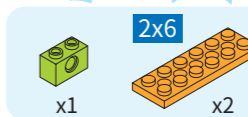

04

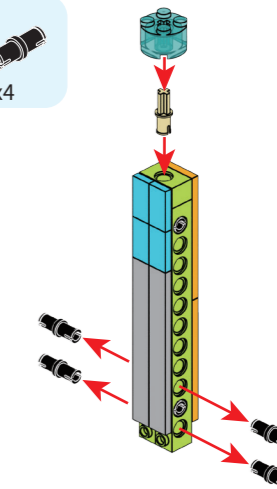
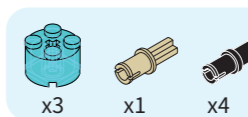

05

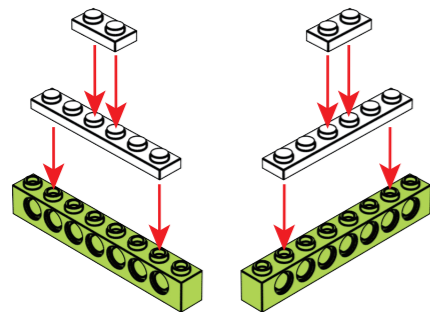
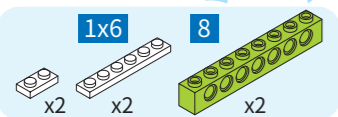

07

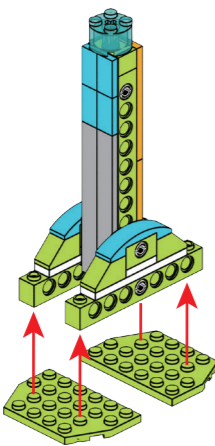
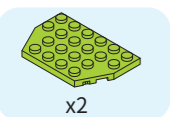

06

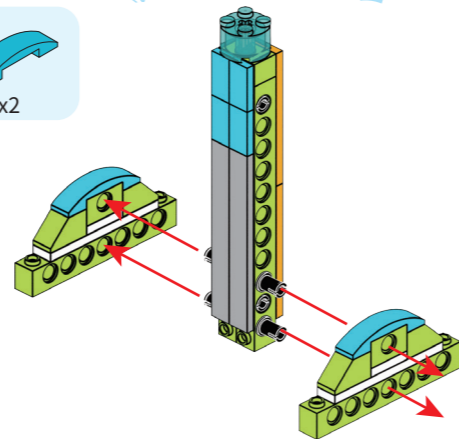
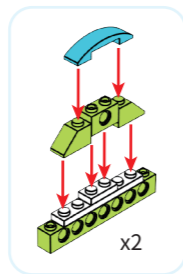

08

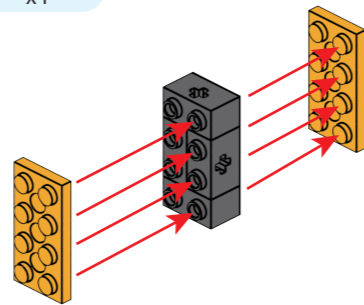
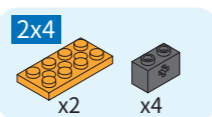

09

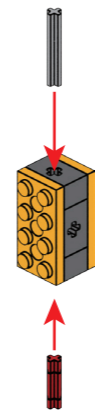
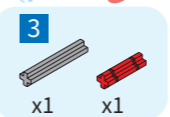

11

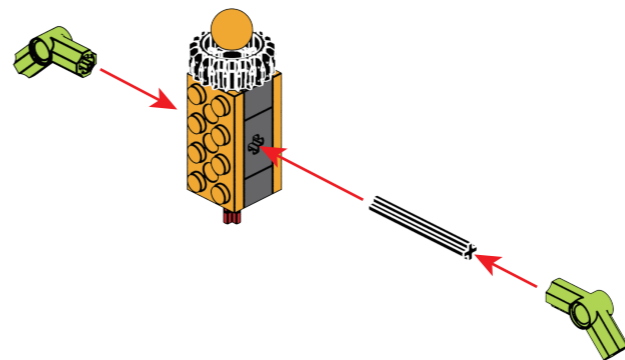
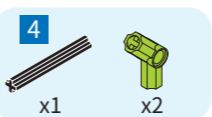

10

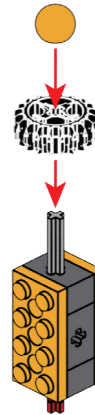

12

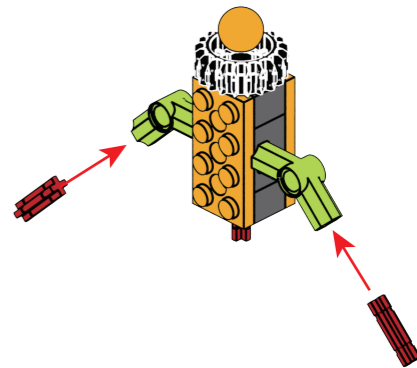

13



x2

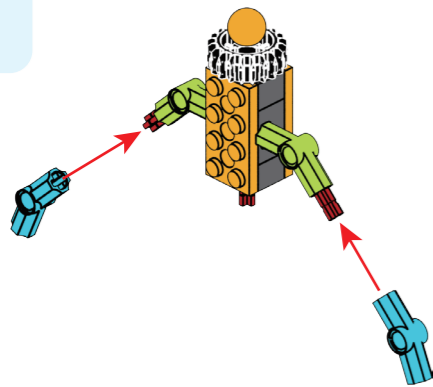

14

6

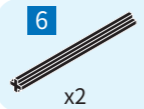

x2

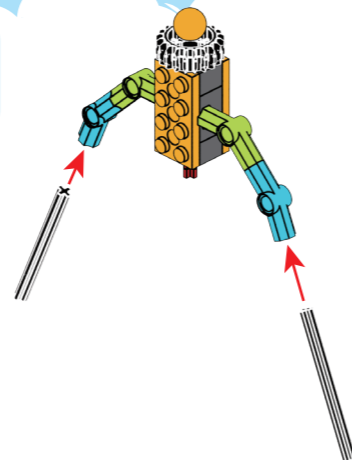

17

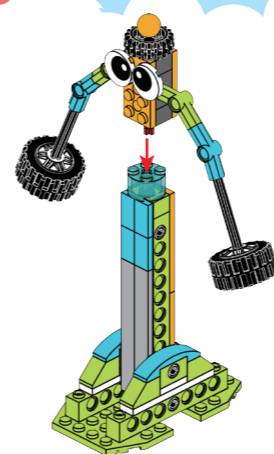

18

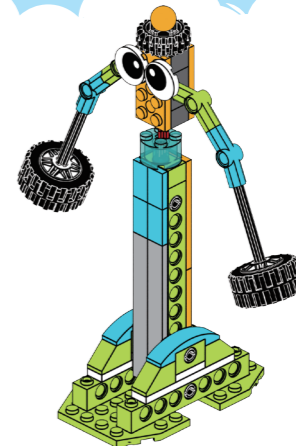

15



x2



x2

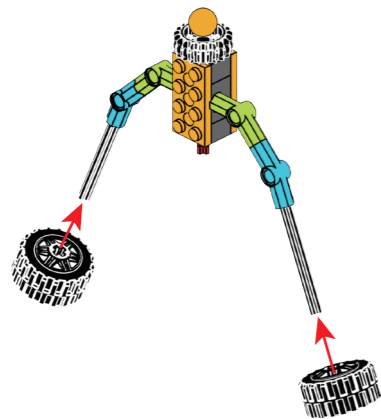

16



x2

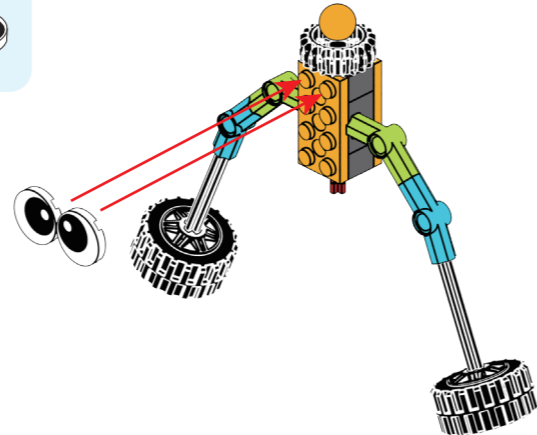

1

Place the tumbler on the base.

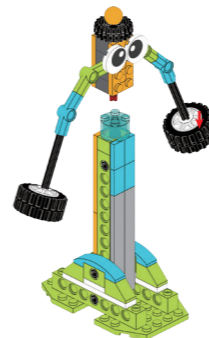

2

Toggle the tumbler.

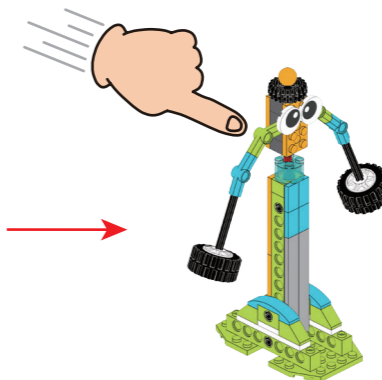

3

The tumbler sways from side to side without falling.

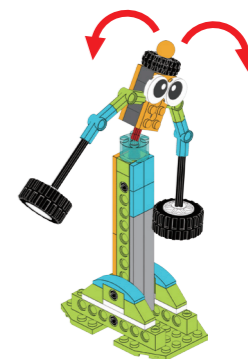

2.4 Lever

There is a famous saying by Archimedes in ancient Greece, that is to give me a fulcrum, I can pry the earth. This sentence contains the knowledge of leverage.



A seesaw is a typical lever. We call a rigid rod that can rotate around a fixed point (fulcrum) under the action of force as a lever. This fixed point is generally called a fulcrum. The lever can be a hard rod of any shape. So in addition to the seesaw, scissors, boards, fishing rods, etc. are all levers. After completing the work, everyone, you can try to find the fulcrum of the lever part of the work.



Think together:
What is the magnitude of lever fulcrum related to? Find out the answer while playing.

Jack

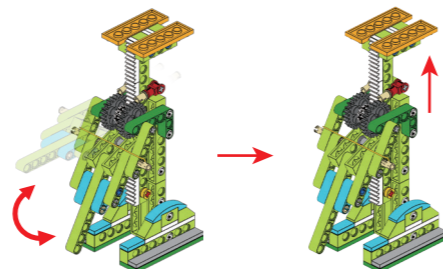
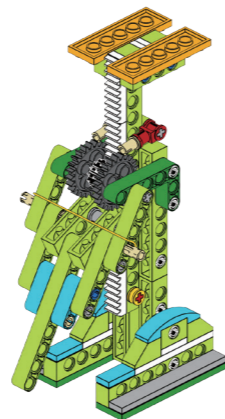

01

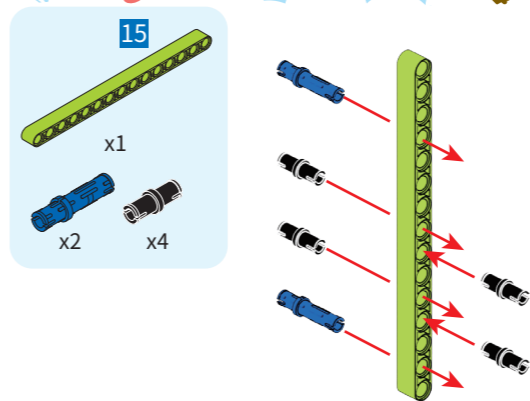

03

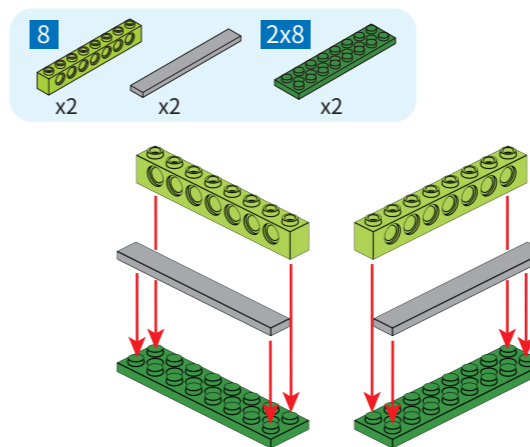

02

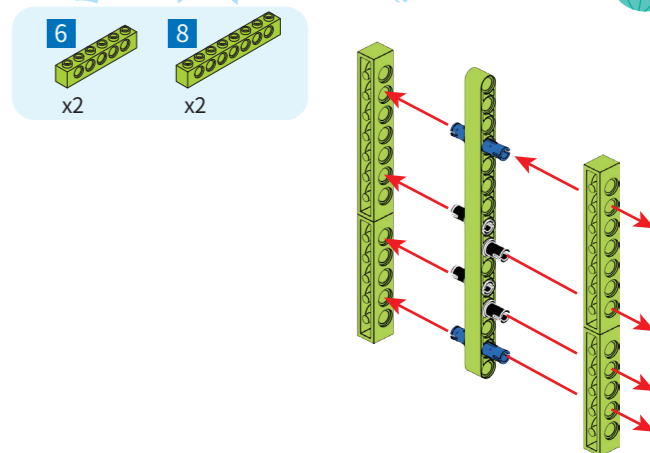

04

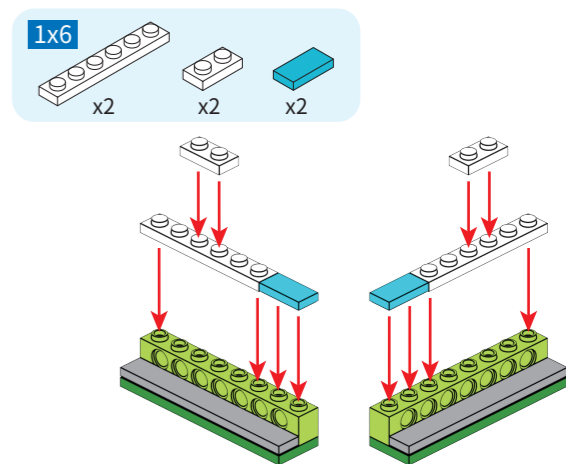

05

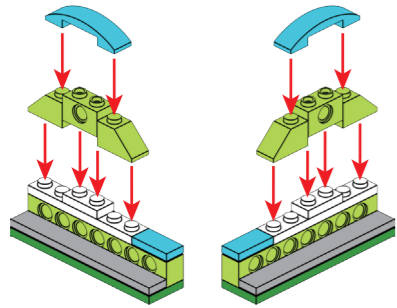
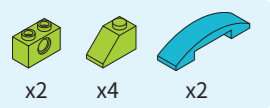

06

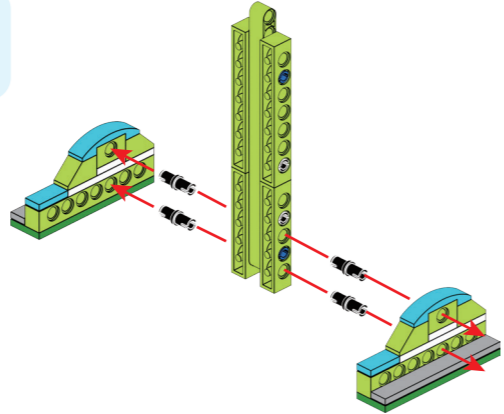

09

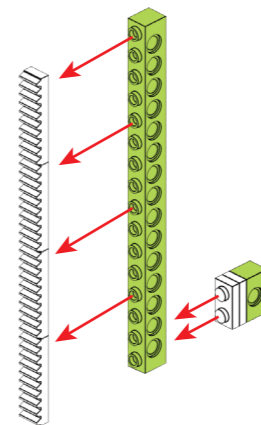
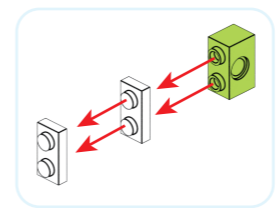
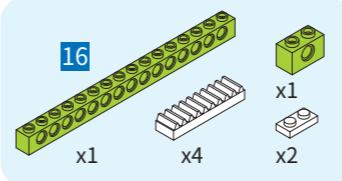

10

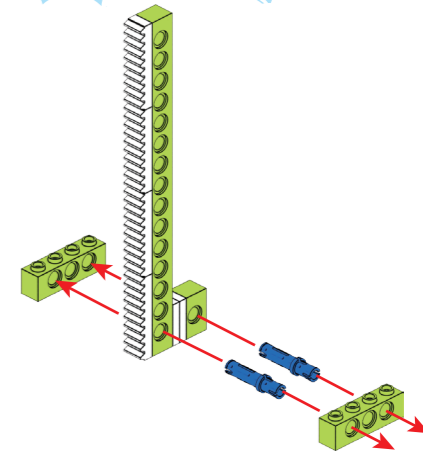
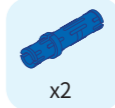

07

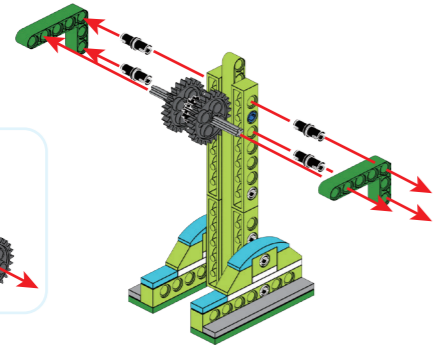
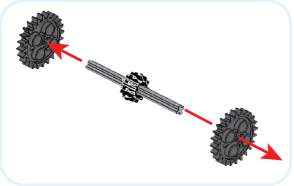
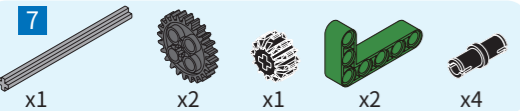

08

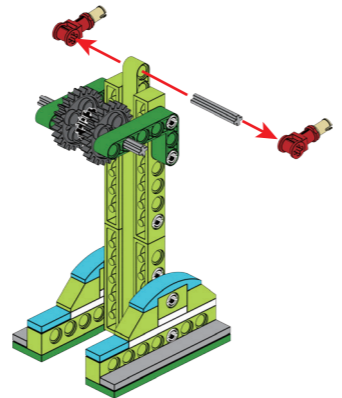
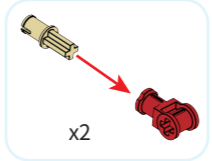

11

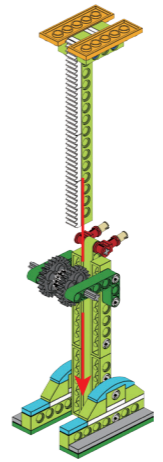
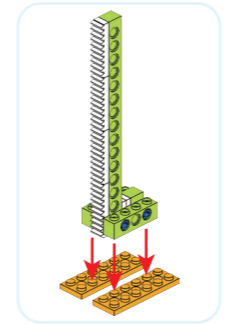
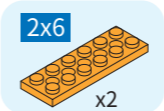

12

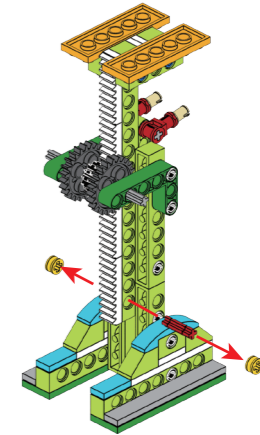
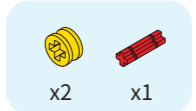

13

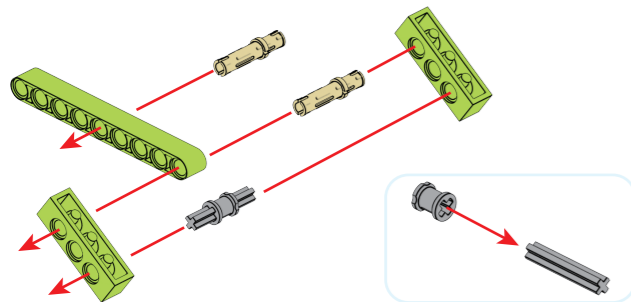
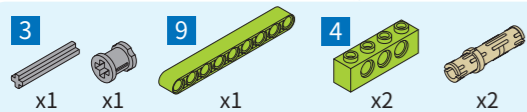

15

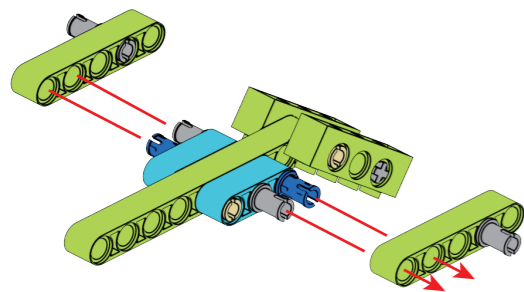
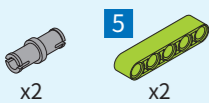

14

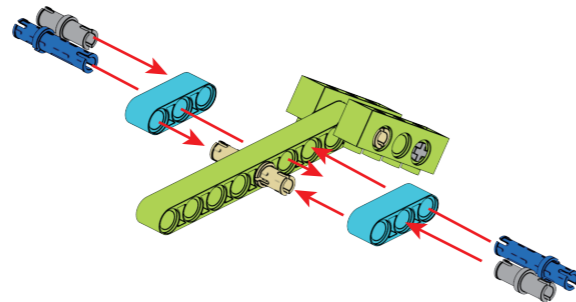
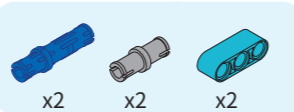

16

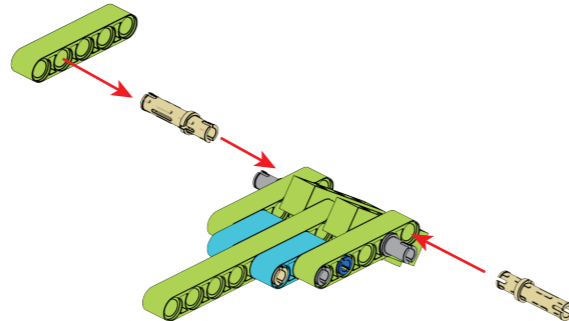
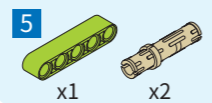

17

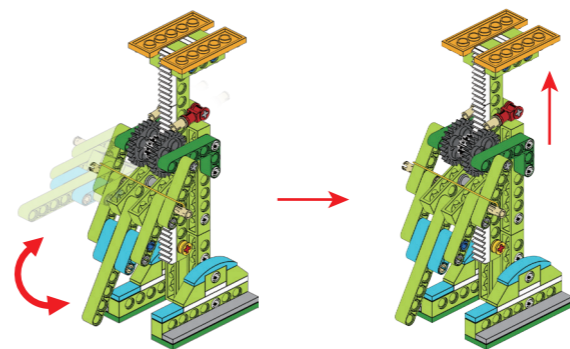
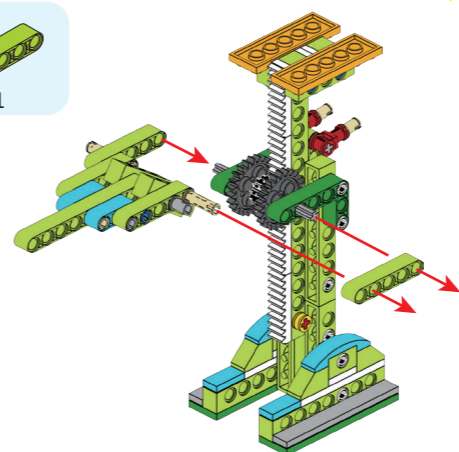
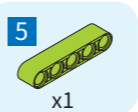

1 Swing the handle.

2 The lifting platform rises.

18

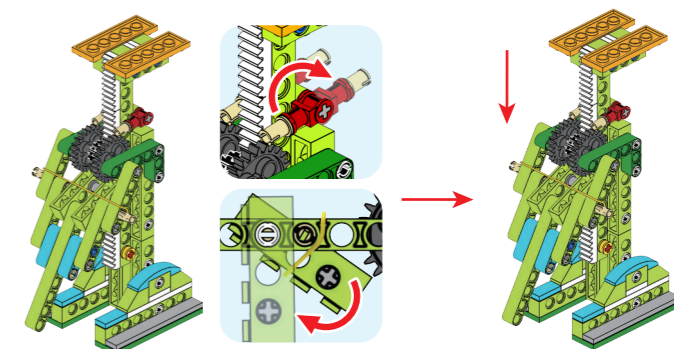
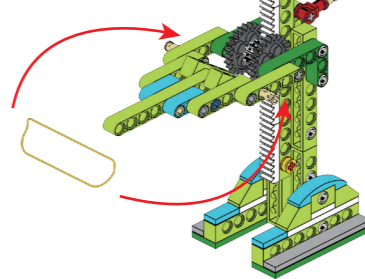

3 Open the buckle.

4 The lifting platform goes down.

2.5 Gyro

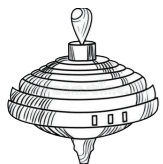

Gyro

The gyro spinning at high speed will not fall. The rotation axis is stable, also called the principle of axial stability.

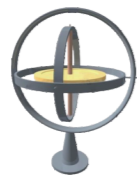

Mechanical Gyro

Based on this feature, the gyro was invented. The gyro is mainly used to measure angle (tilt), speed, azimuth, etc., and can be used for navigation and tracking.

Practical Application



The gyroscope senses the posture and keeps it steady.



The gyroscope is used for navigation and tracking.

Think together:

What is the connection between the speed of the gyro and its shaking degree? Find out the answer while playing.

Trigger Gyro

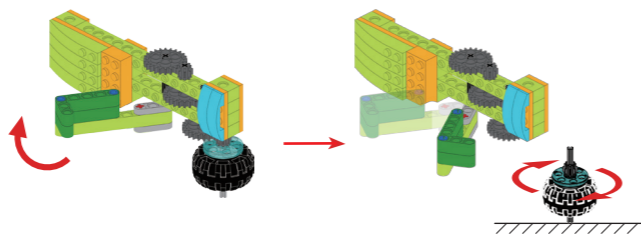
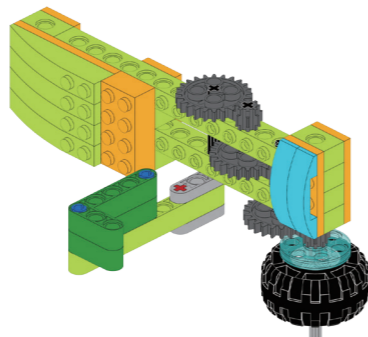

01

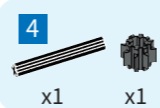

x1 x1



1:1

03

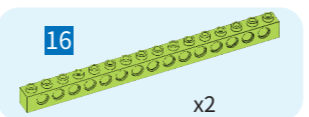

x2

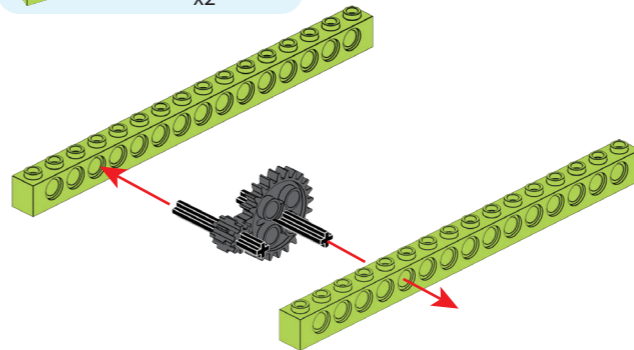

02

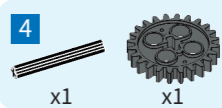

x1 x1

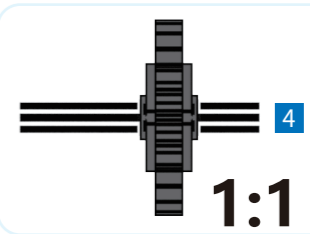

1:1

04

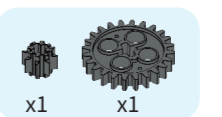

x1 x1

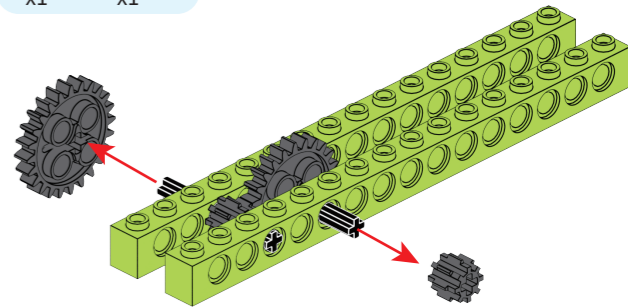

05

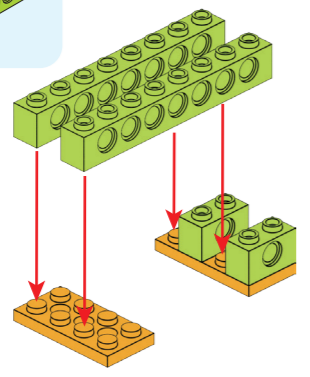
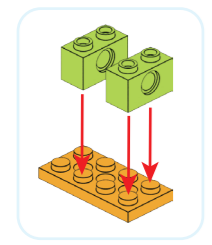
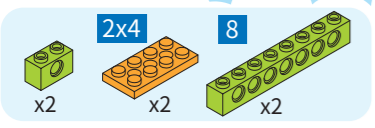

06

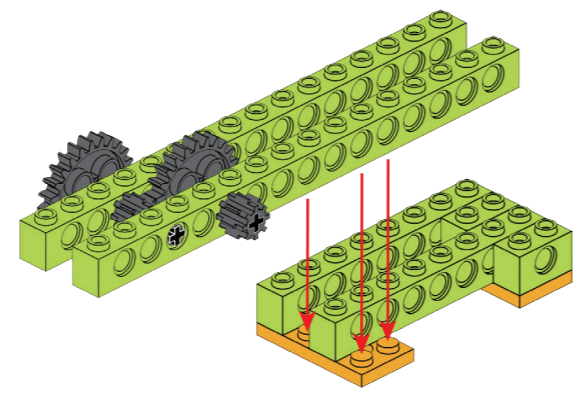

07

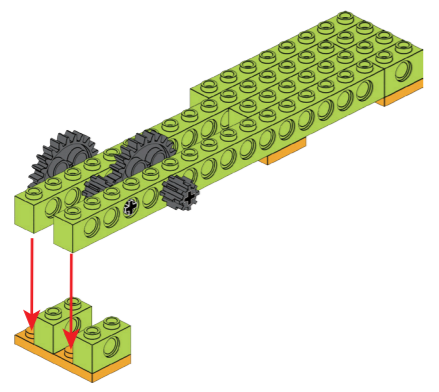
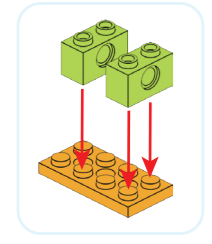
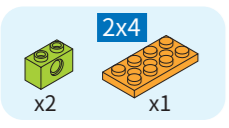

08

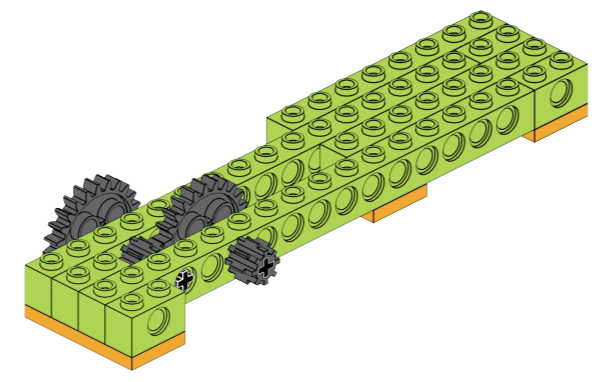

09

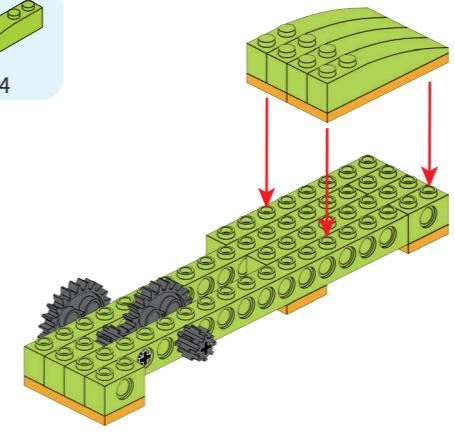
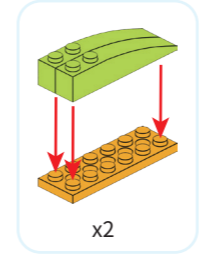
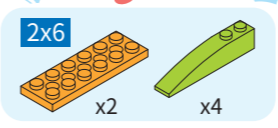

10

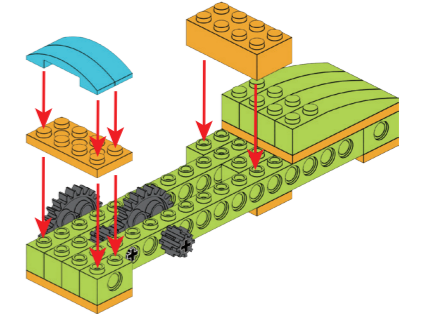

11

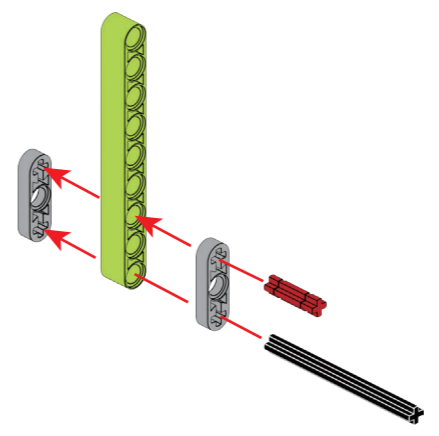
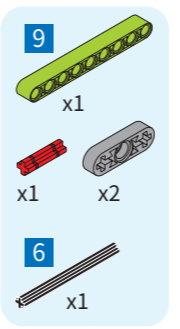

12

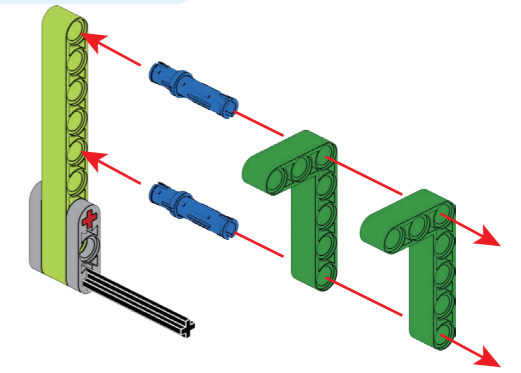
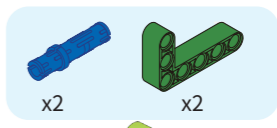

13

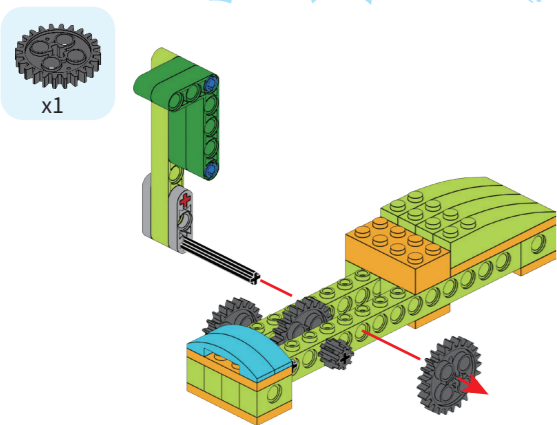

14

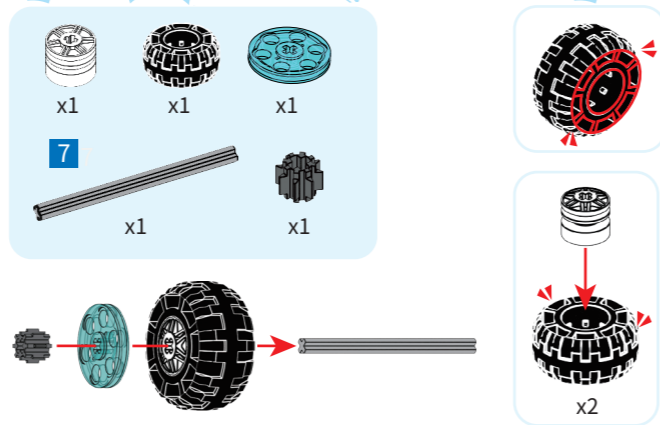

15

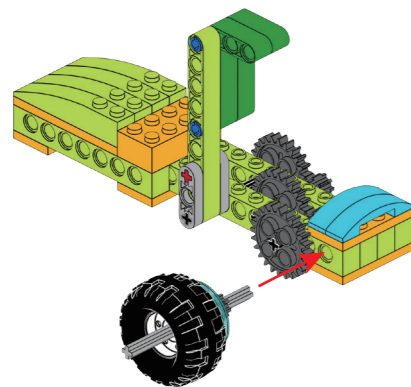

16

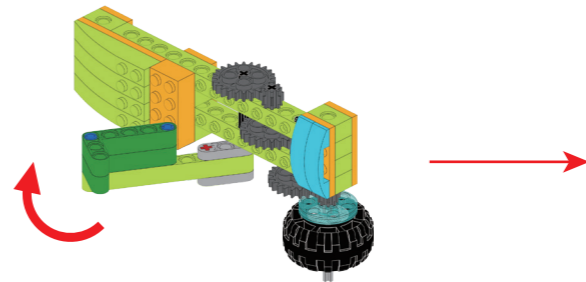
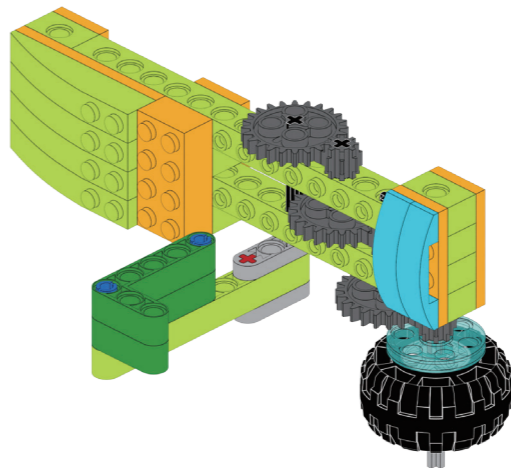
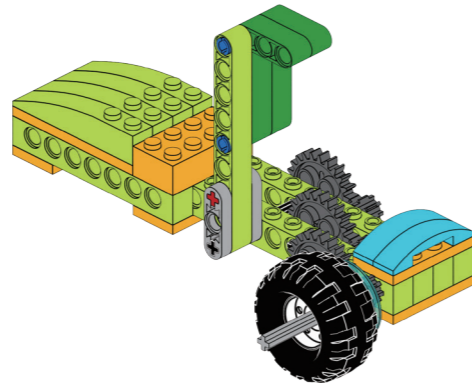

1 Pull the trigger back.

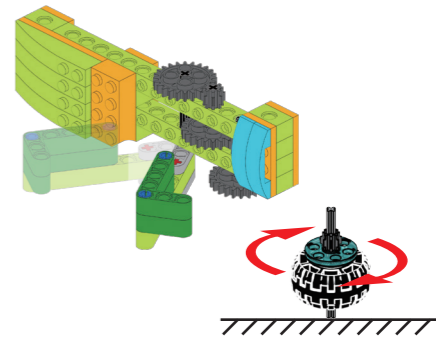

2 The gyro spins off the ground.

Grip Gyro

01

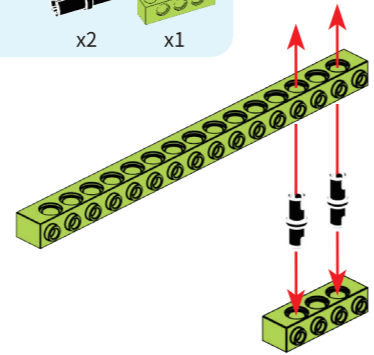
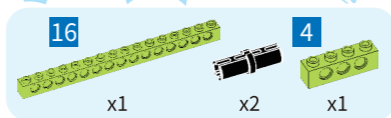

02

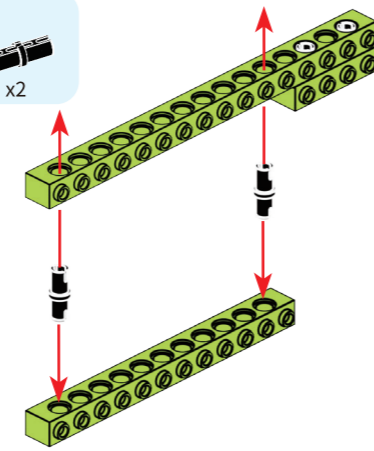
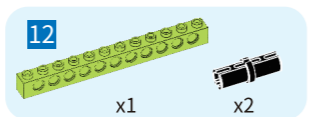

03

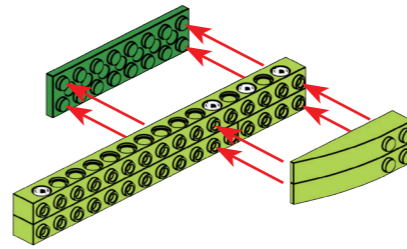
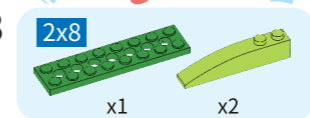

04

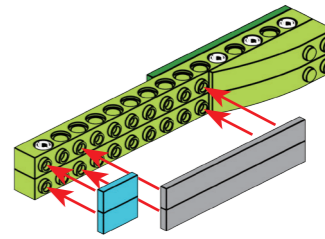
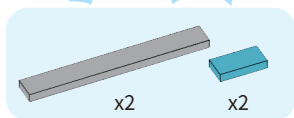

05

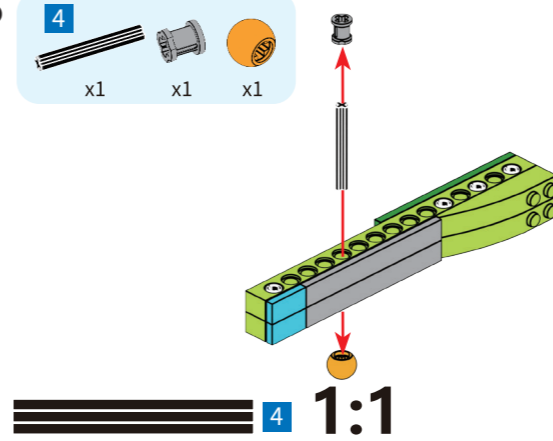
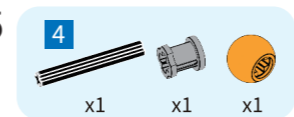

06

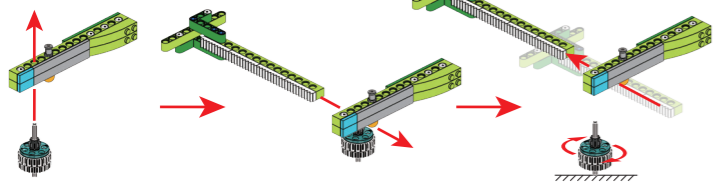
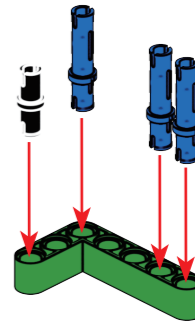
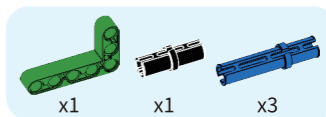

07

9

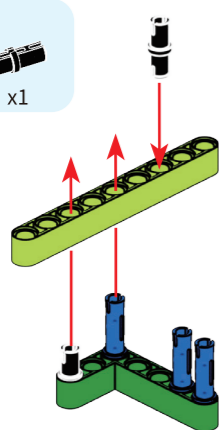
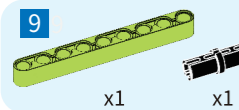

09

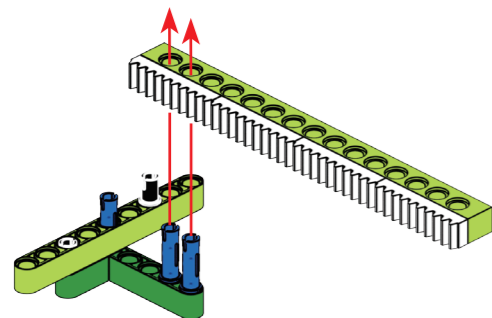

08

16

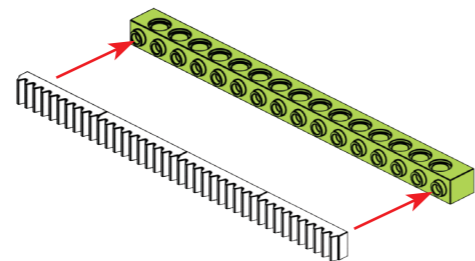
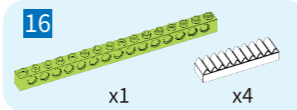

10

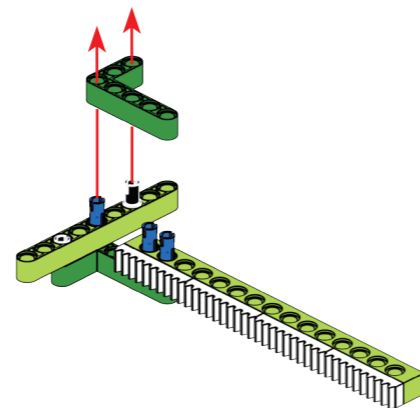
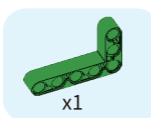

11

6

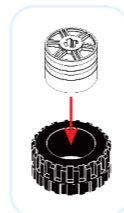

1:1 6

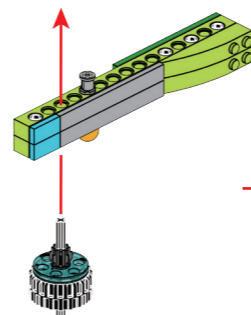
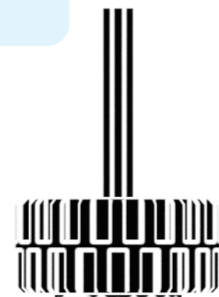

1 Put on the gyro.

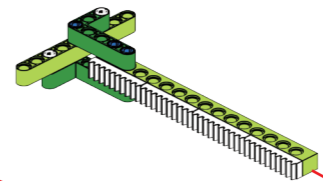

2 Insert the pull bar.

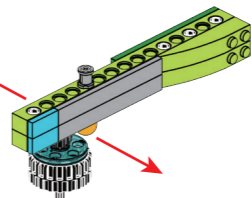

3 Pull out the pull bar, and the gyro rotates on the plane.

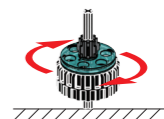

12

6

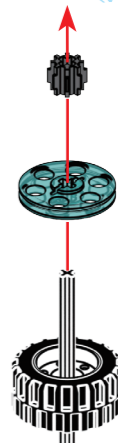
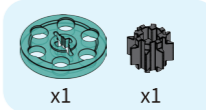

2.6 Hand Fan

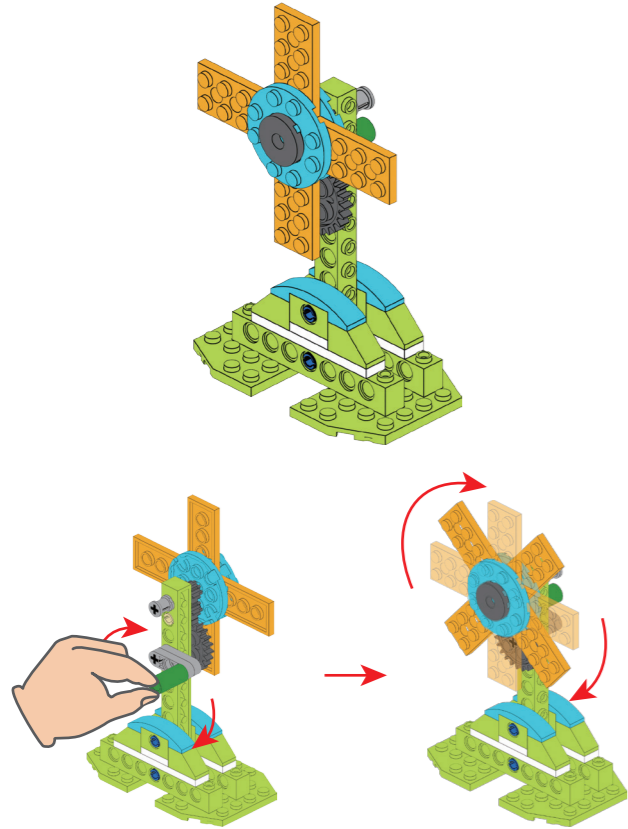

01

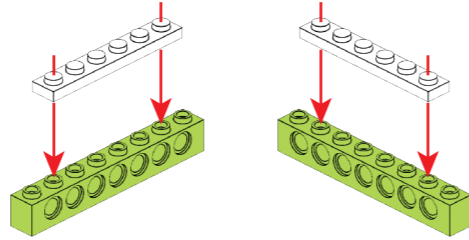
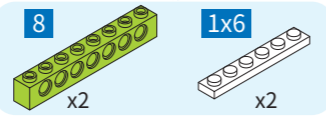

02

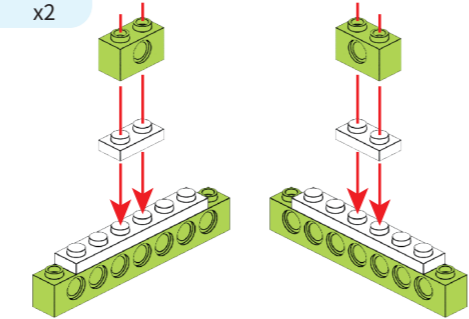
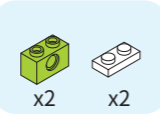

03

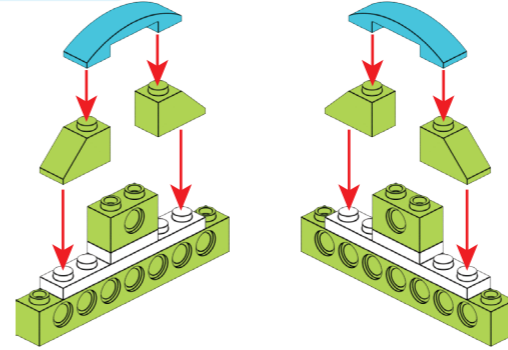
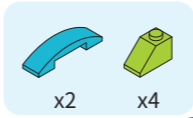

05

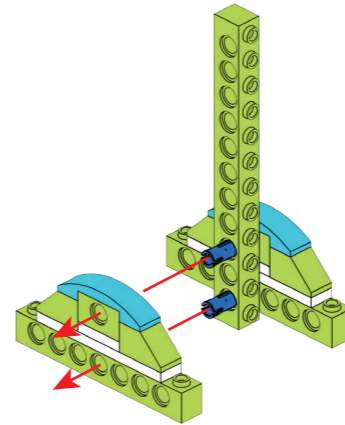

04

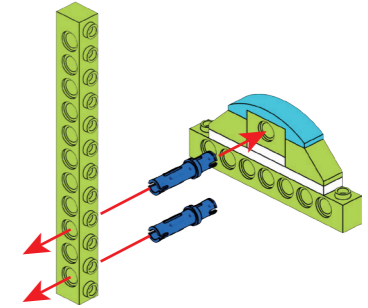
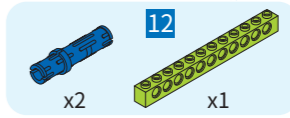

06

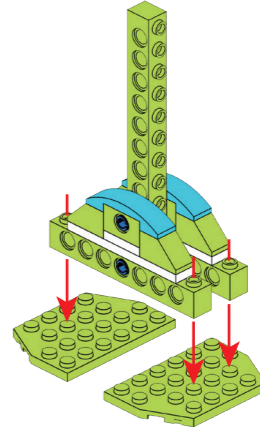
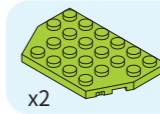

07

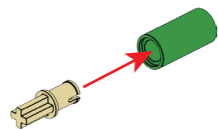
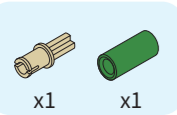

08

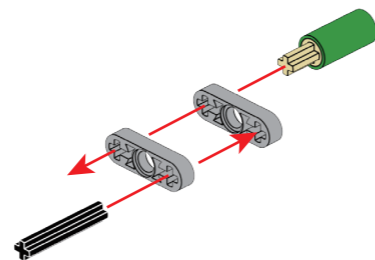
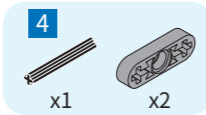

09

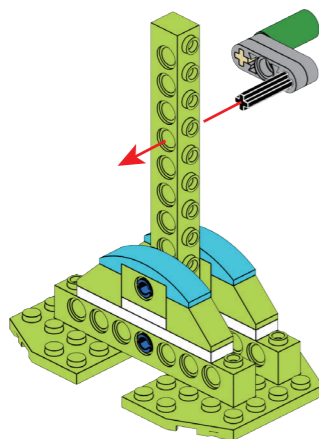

10

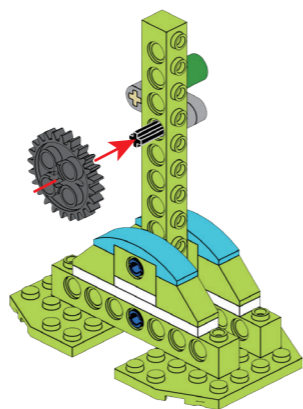
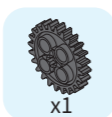

11

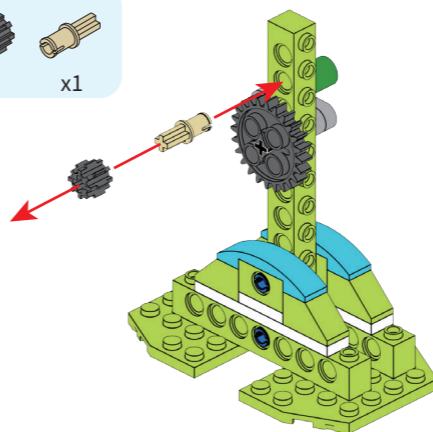
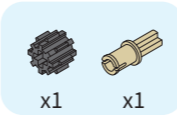

13

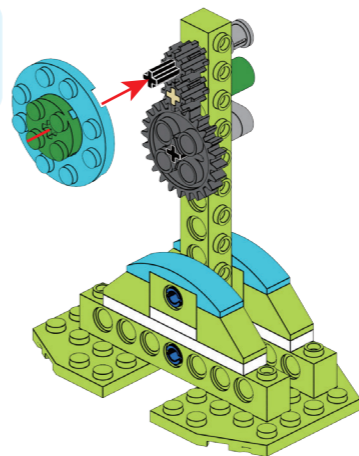
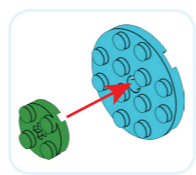
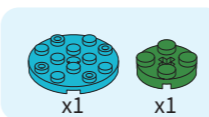

12

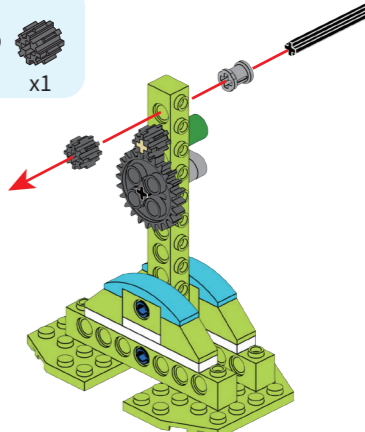
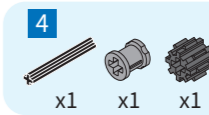

14

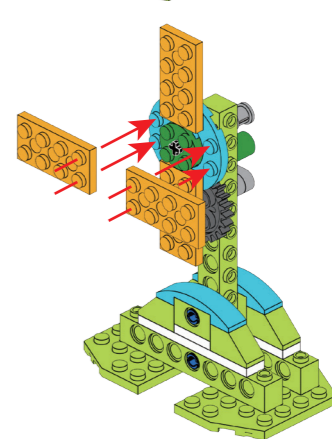
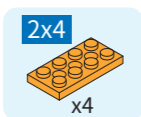

15

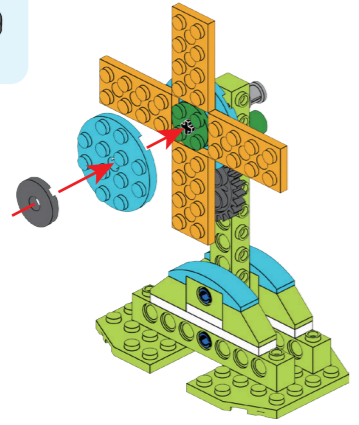
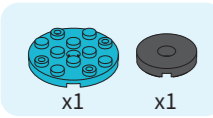

16

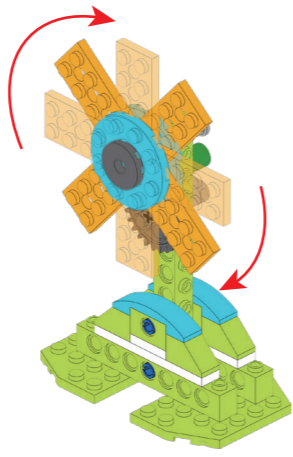
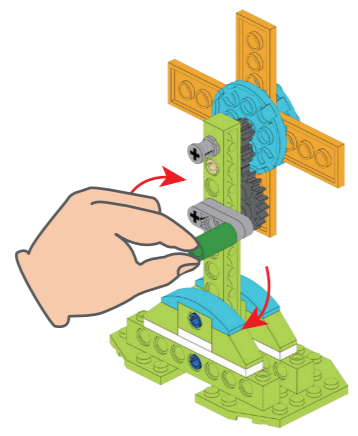
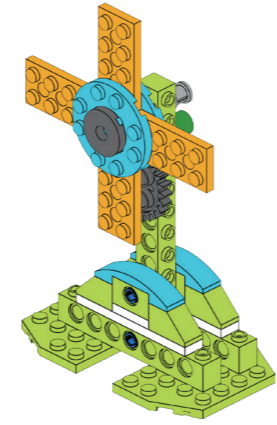

2.7 Spinning YL-Man

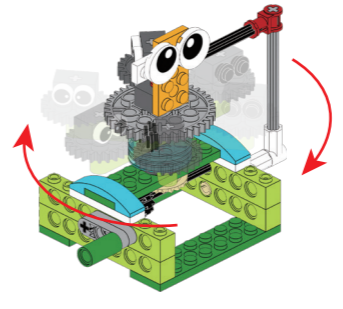
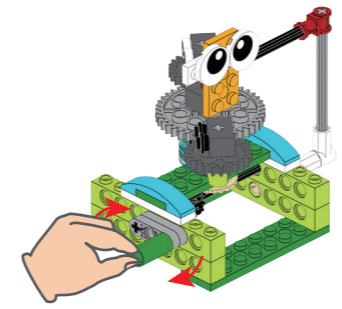
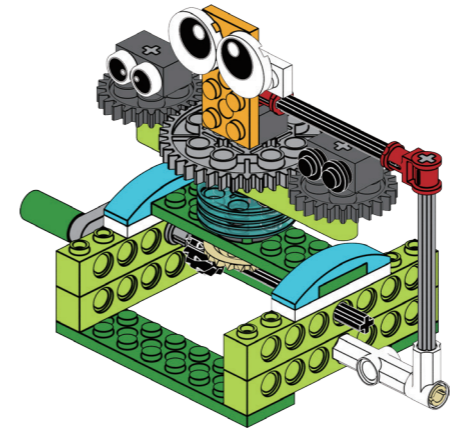

01

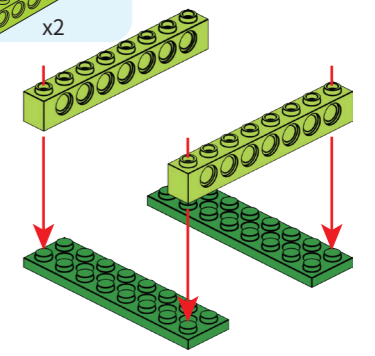
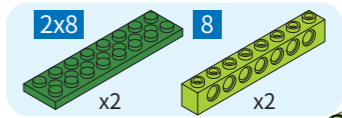

02

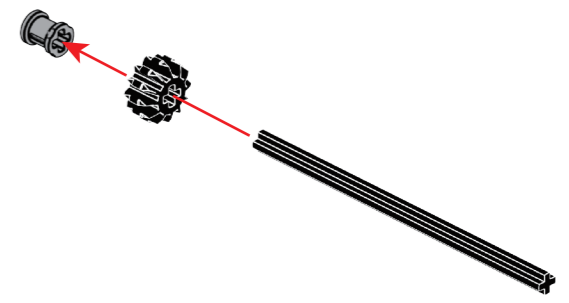
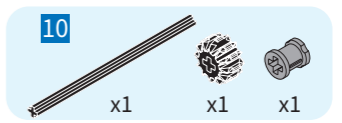

03

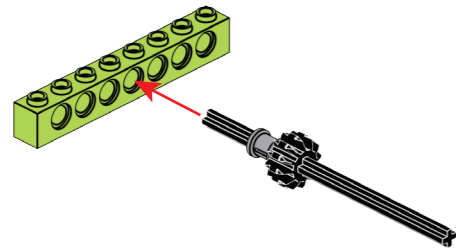
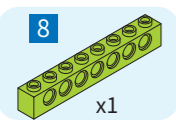

05

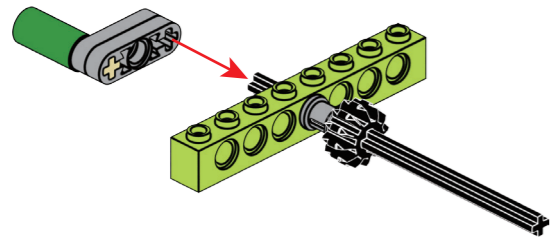

04

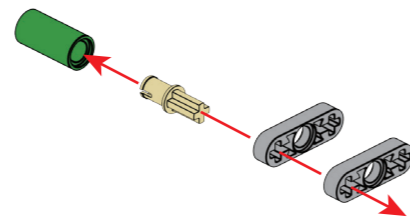
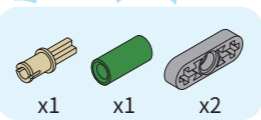

06

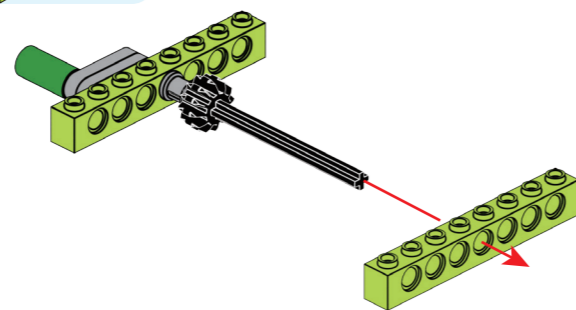
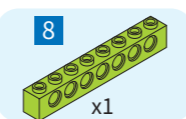

07

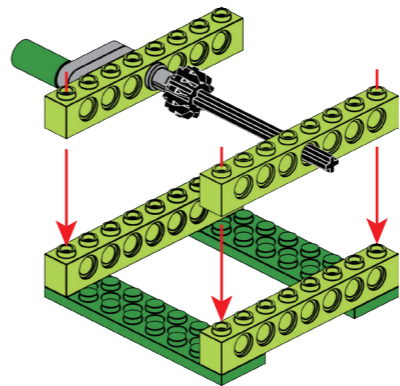

09

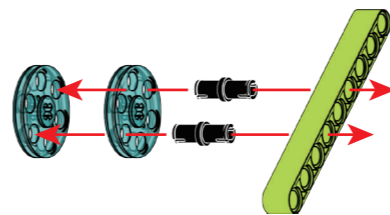

08

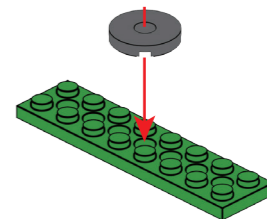
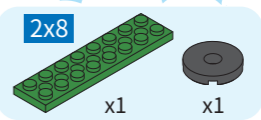

10

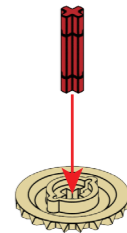
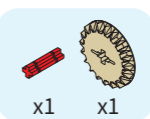

11

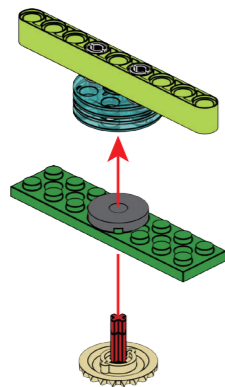

12

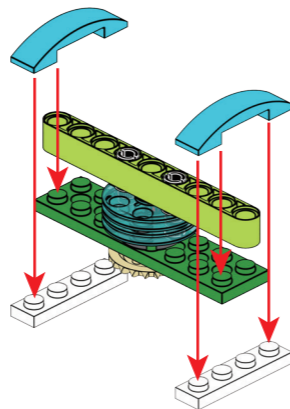
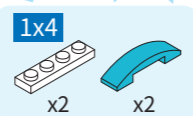

15

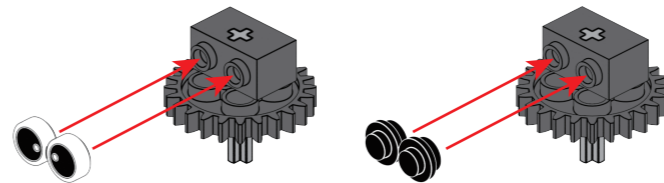

16

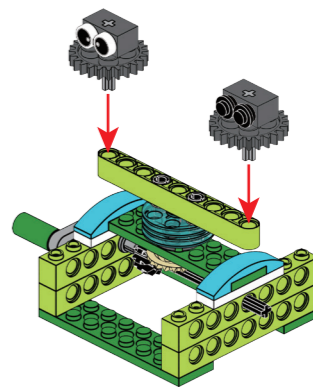

13

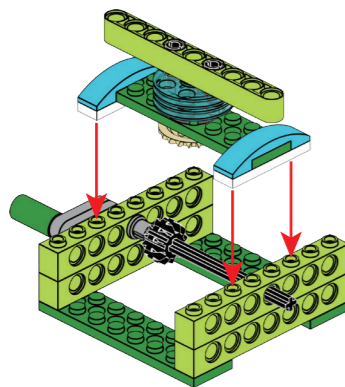

14

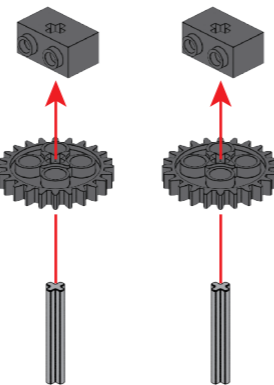
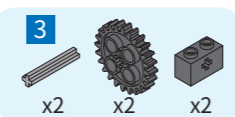

17

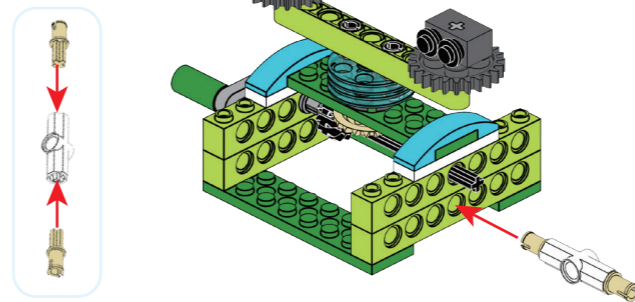
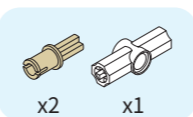

18

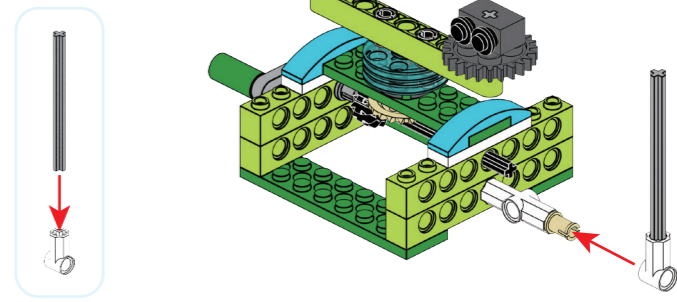
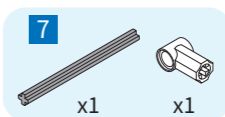

19

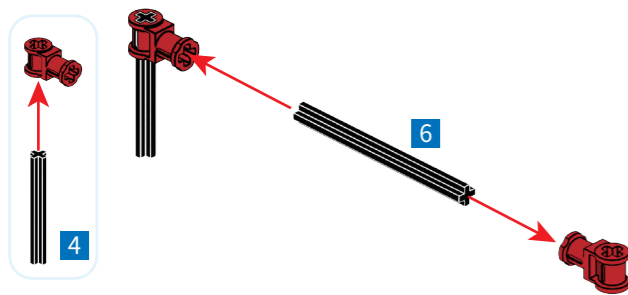
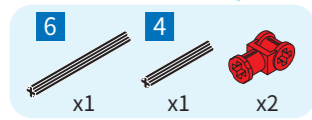

21

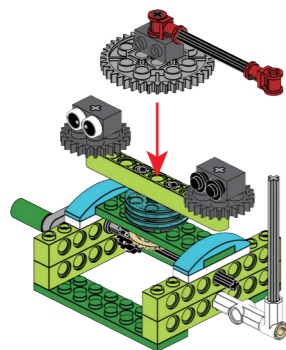

20

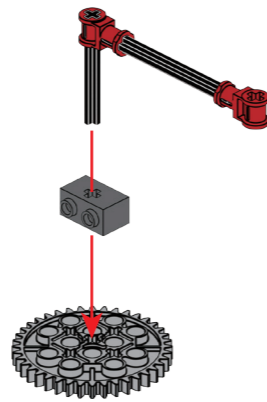
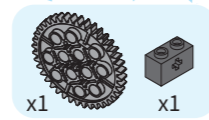

22

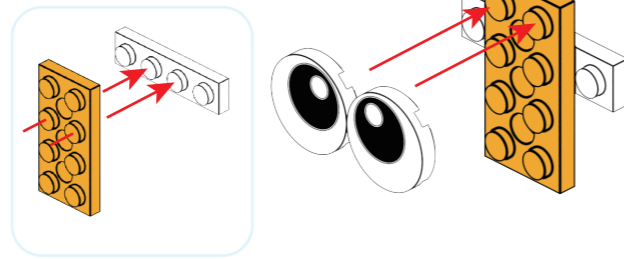
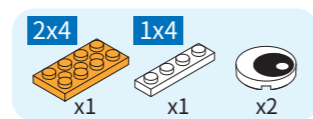

23

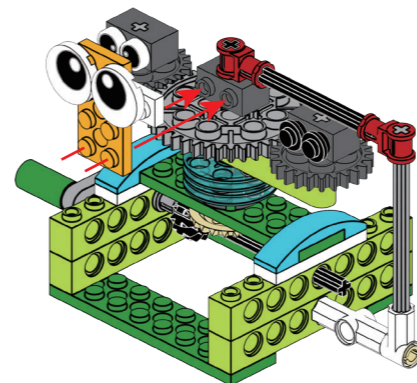

24

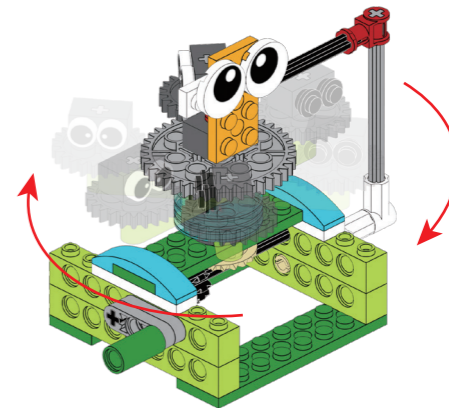
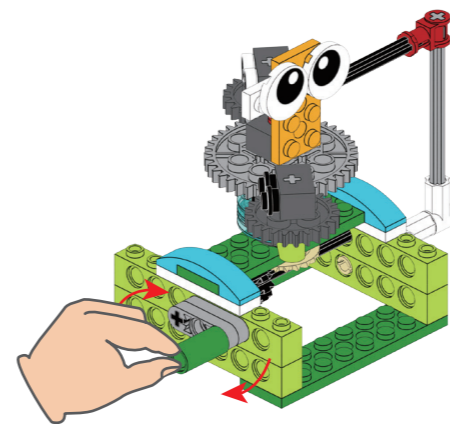
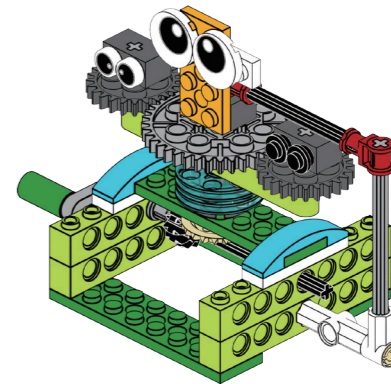

3 Robot Parts List

This kit contains 300+ parts, which can meet the sequential building of 100 kinds of models. Please note they are not built at the same time. The parts are divided into plates (the thickness of the plate is 1/3 of the brick), bricks, arms (compared to bricks with holes, both ends of the arms are symmetrical, which is more widely applicable), shafts, pulleys and gears, as well as connectors and bushings, rubber bands, starters and other accessories.

Plates

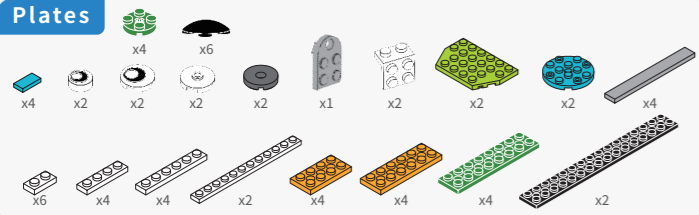

Shafts and Pins

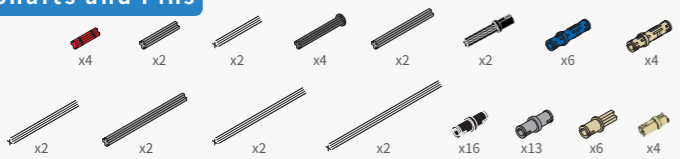

Connectors

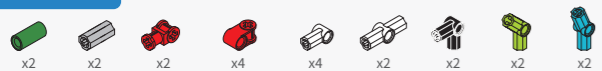

Gears



Bricks

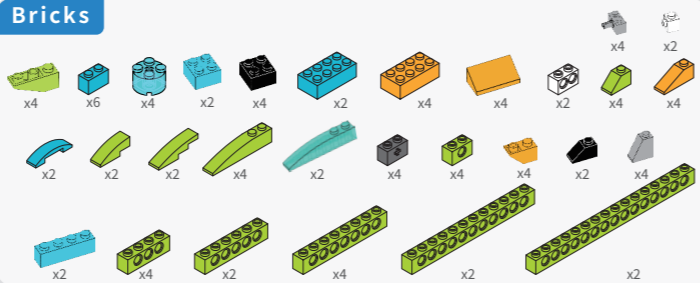

Arms



Other Accessories



4 Product Details

Product Name: Diverse Building Blocks Manual

Model No.: MKZ-BK-DB

Suitable for: 4+

Made IN China

Warning! Do not aim at the eyes or face.

Warning! Do not use projectiles not provided by the manufacturer.

Warning! This product contains small accessories, it is not for children under 3 years old.

Warning! This product contains small balls, which may cause a choking hazard and is not suitable for children under three years of age.

The user manual contains important information, please keep it for future use.

Rechargeable batteries should be charged under the supervision of an adult.

Maintenance: This product shall not be used in water or a humid environment.

Remove surface strains with a dry cloth before use.