



makerzoid

Manual Future Mechanic

Big Building Blocks Construction Team

Find more ideas here.



iOS



Android

APP Download

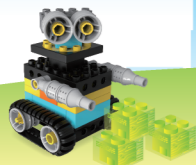
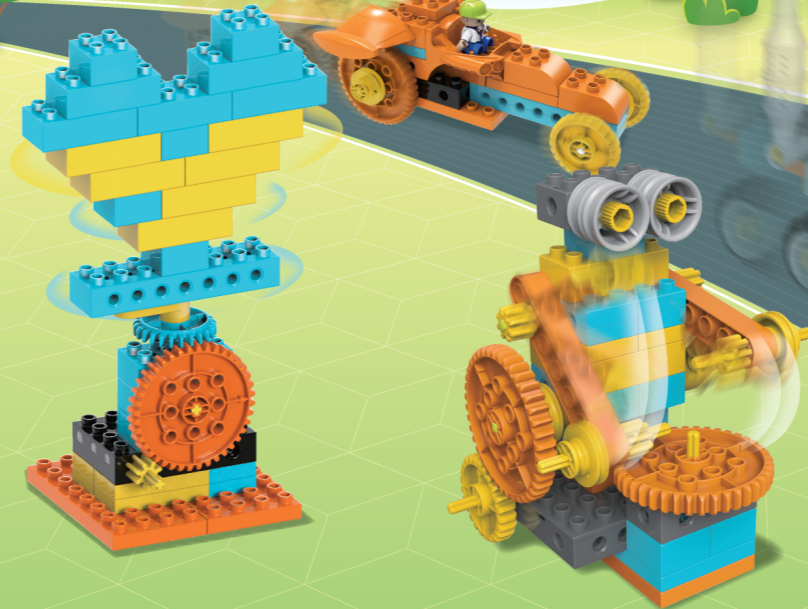

Contents

Screwdriver Introduction.....	01	Dump Truck.....	24
Host Controller Introduction.....	02	Steamroller.....	26
Remote Controller Introduction.....	04	Collection Robot.....	28
Climbing Truck.....	06	Spinning Gyroscope.....	30
Crawling Ladder.....	08	Rice Field Guardian.....	32
Control The Climbing Truck.....	10	Intelligent Barrier Gate.....	34
Climbing Race.....	12	Electric Drill.....	38
Tumbler.....	14	Magic Planet.....	42
Rain Cleaner.....	16	Spinning Heart.....	44
Excavator.....	18	Cargo Conveyor.....	46
Bulldozer.....	20	Happy Party.....	50
Crane.....	22	Product Information.....	53

Screwdriver Introduction

When turning the keyhole with the specialized screwdriver, it makes a lively and interesting 'click-click-click' sound.

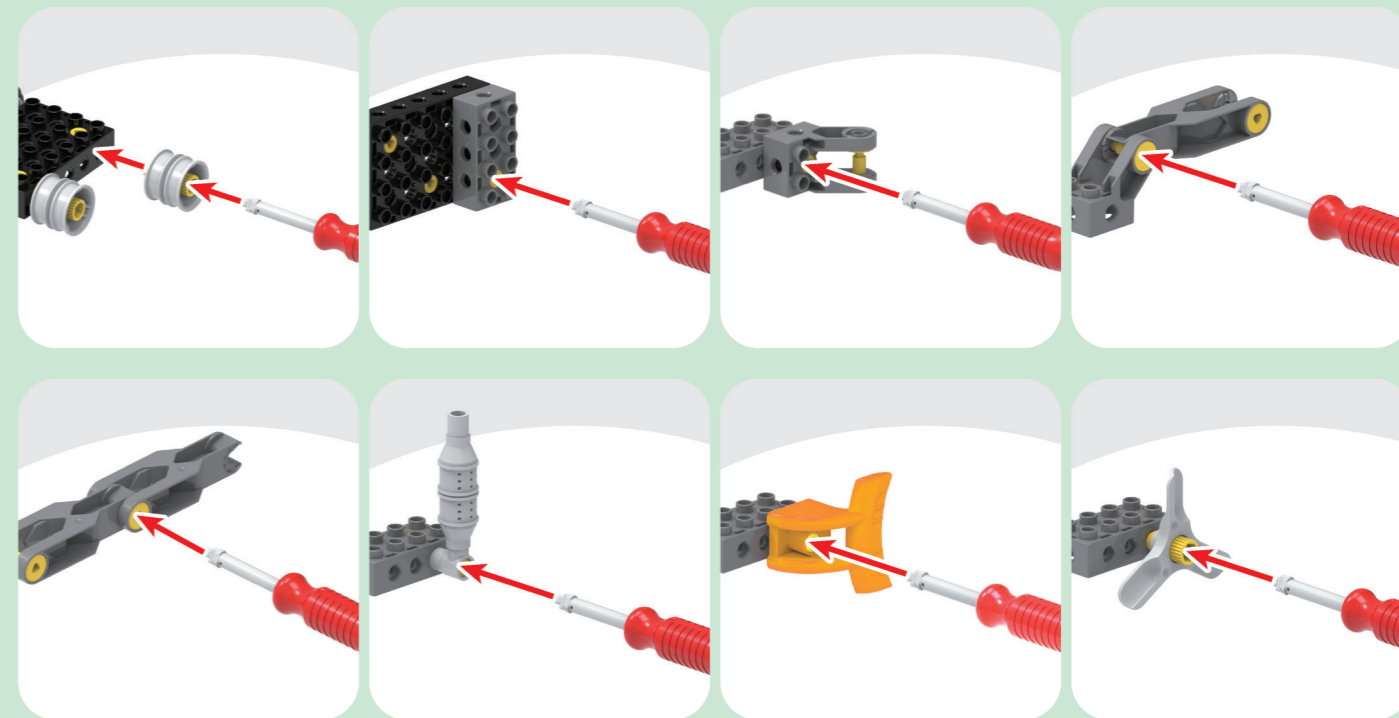

Host Controller Introduction

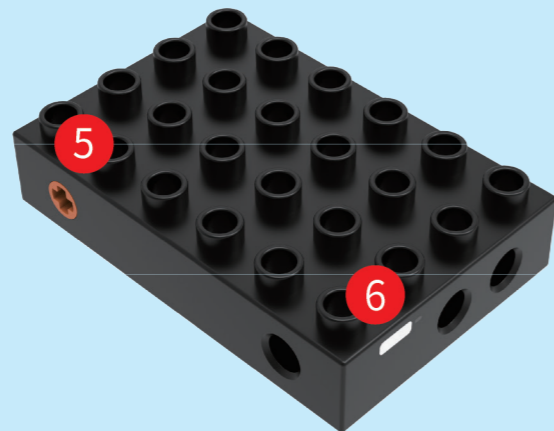

1. Motor 1 Output Port

2. Motor 1 Button (Short Press for Clockwise, Long Press for Counterclockwise)

3. Power Button

4. Motor 2 Button (Short Press for

Counterclockwise, Long Press for Clockwise)

5. Motor 2 Output Port

6. Charging Port

Charging Instructions for the Host Controller

Connect the USB end of the charging cable to a power adapter, computer, or any USB-enabled digital device that supports charging.

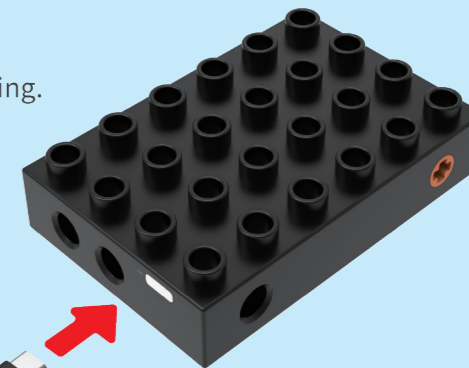

Plug the Type-C end of the charging cable into the charging port on the host controller.

Precautions

- Regular Inspection: Regularly check the cables, plugs, housing, and other components for damage. If any damage is found, stop using it until it is repaired.
- The toy must not be connected to more than one power source at a time.
- The toy is not suitable for children under 3 years old.
- The toy should only be used with the recommended transformer.
- The transformer is not a toy.
- Do not alter the circuit structure. The toy cannot be used while charging.
- Use a charger with an output of 5V/0.5A for charging the host controller.

Remote Controller Introduction

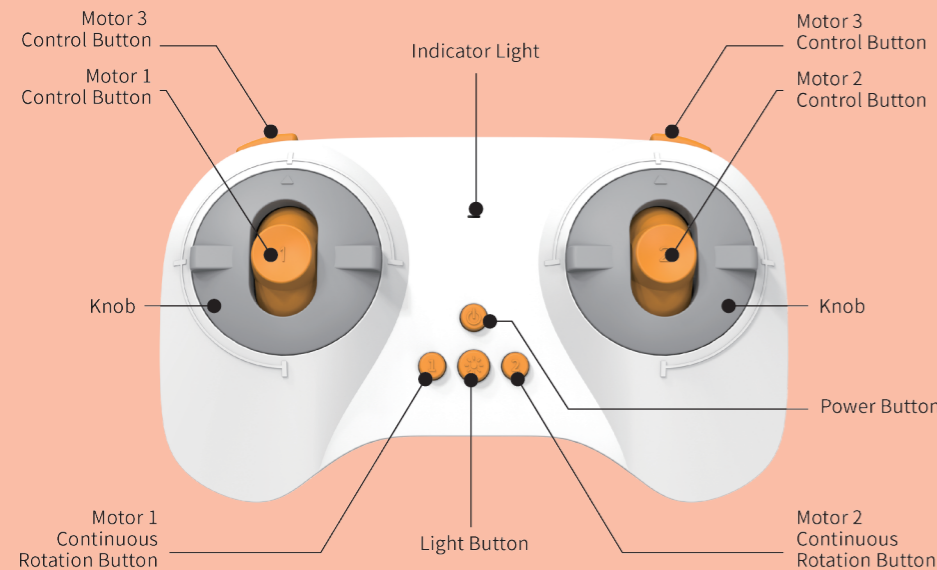

How To Use The Remote Controller

Power Button

1. Re-pairing: Remove the battery cover and take out BOTH of the batteries. Then put them back inside. LED light flashes quickly meaning the remote controller is searching for a new host controller to be paired.
2. Short Press: Connect to a paired host controller.

Motor 1 and Motor 2 Continuous Rotation Buttons

1. Short Press after Power On: Motor rotates counterclockwise. (Red Light on the Motor 1 or 2 Button on the host controller)
2. Long Press after Power On: Motor rotates in clockwise. (Green Light on the Motor 1 or 2 Button on the host controller)

Motor 1 & Motor 2 Control Buttons



When the indicator on the Knob locates on the top, push the Motor 1 Control Button backwards and Motor 2 Control Button forward simultaneously to control the robot go forward.

When the indicator on the Knob locates on the top, push the Motor 1 Control Button forward and Motor 2 Control Button backwards simultaneously to control the robot go backwards.

Light Button (Feature Not Enabled) Motor 3 Control Button (Feature Not Enabled)

- #### Product Specifications
1. Connection Method: 2.4GHz
 2. Remote Control Range: Up to 15 meters under normal conditions

Battery Precautions

1. Non-rechargeable batteries should not be charged.
2. Rechargeable batteries should be charged under adult supervision.
3. Do not mix different types or old and new batteries.
4. Exhausted batteries should be removed from the product.
5. The toy must not be connected to more than one power source.
6. Rechargeable batteries should be removed from the toy before charging.
7. Ensure batteries are inserted with the correct polarity.
8. Battery terminals must not be short-circuited.
9. This product does not contain batteries.

1. Remove the battery cover from the back of the remote controller.

2. Insert two pcs of AAA batteries.

3. Reinsert the battery cover into the remote controller.

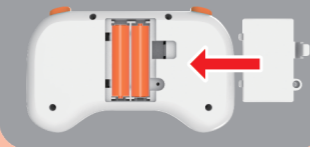
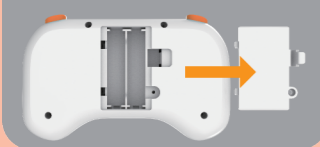

Connec the Remote Control to the Host Controller

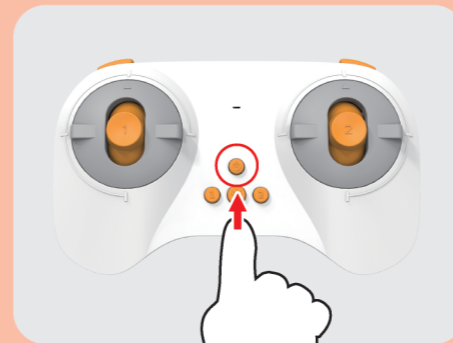

Turn on the remote controller.



The red light on the remote will flash when it's powered on.

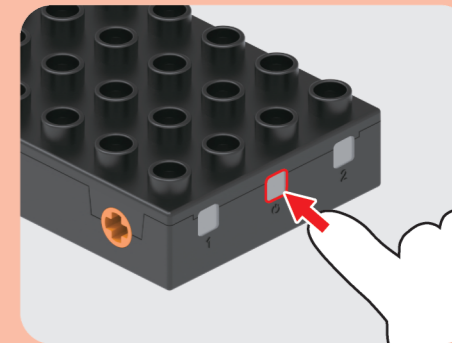

Press the power button on the host controller.



The blue light of the host controller will be on when it's powered on.

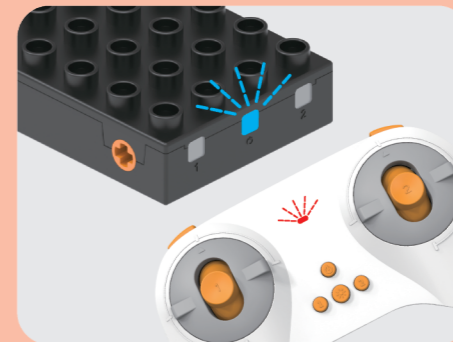

Bring the remote control close to the host controller. The remote and host controller will start pairing.

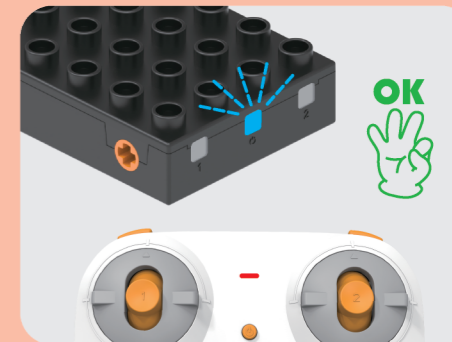

When the red light on the remote controller stops flashing, it's successfully connected to the host controller.

Climbing Truck

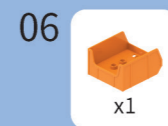
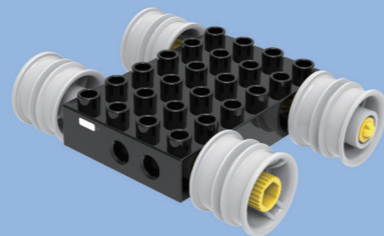
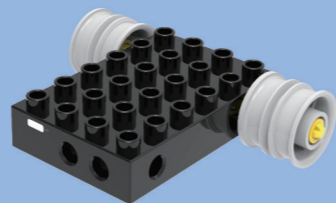

Crawling Ladder

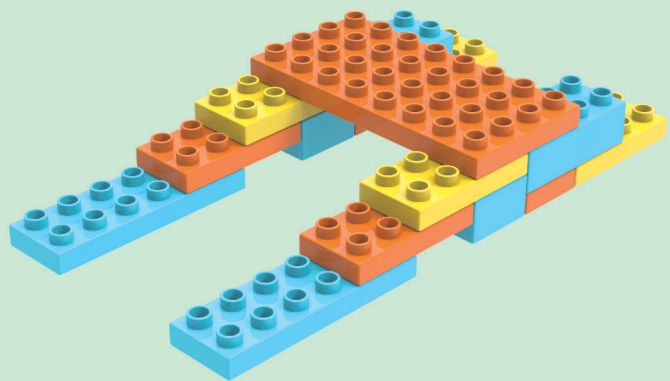

01

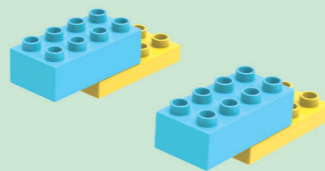
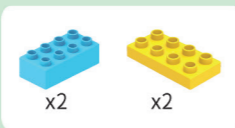

02

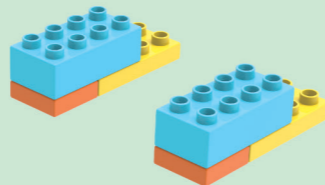

03

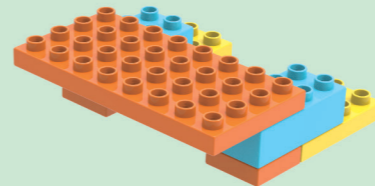
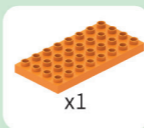

05

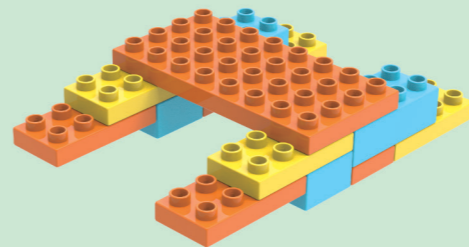

04

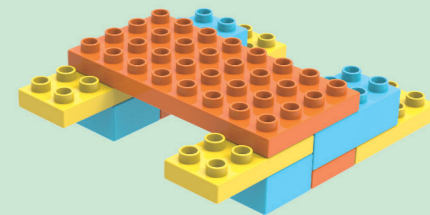
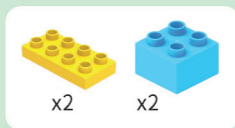

06

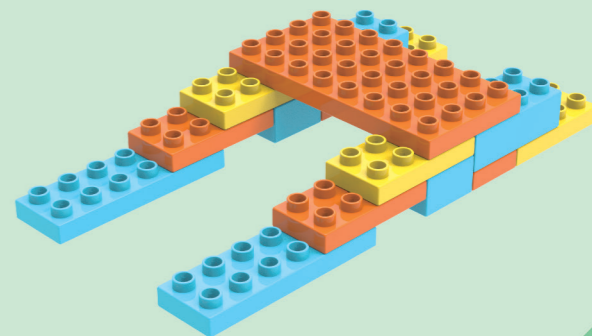

Control The Climbing Truck



01

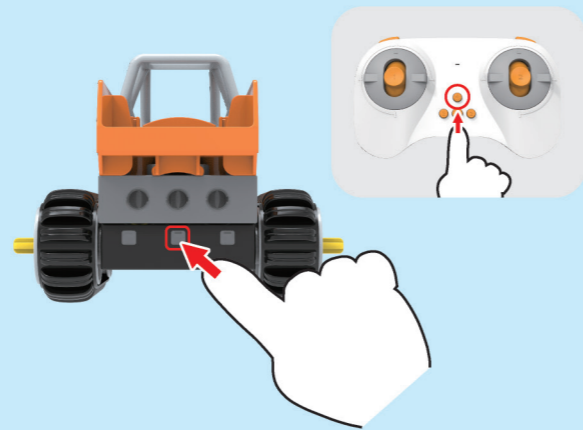

02



03



05



04



06



Climbing Race



01

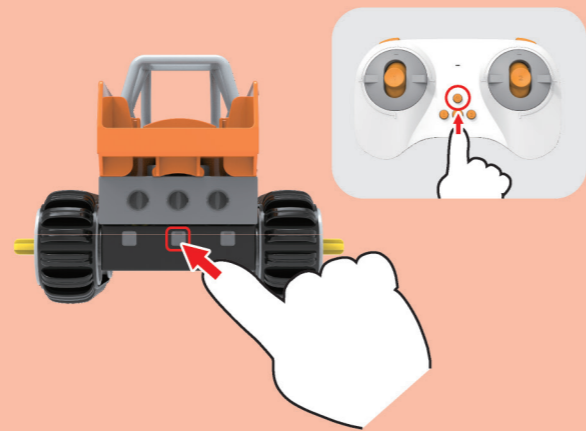

02



Difficulty

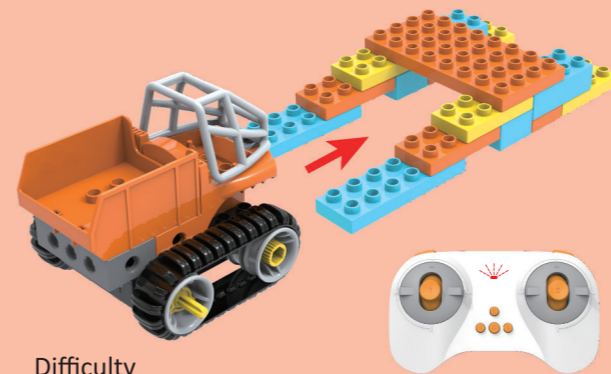

Difficulty

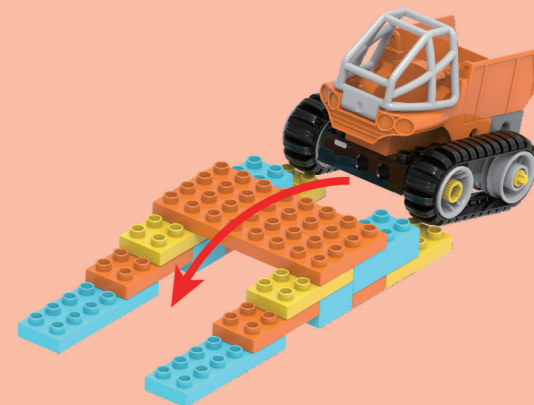
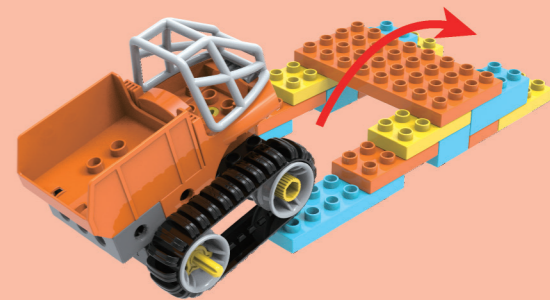
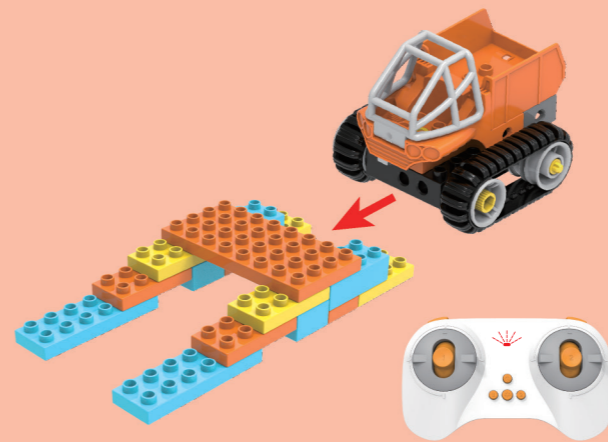

Tumbler

01

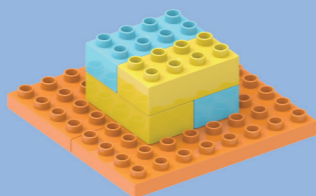
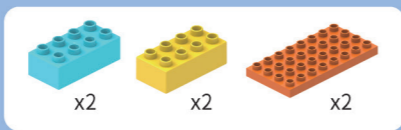

02

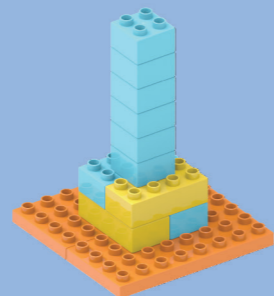

03

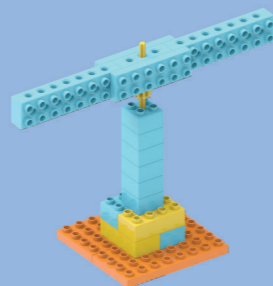
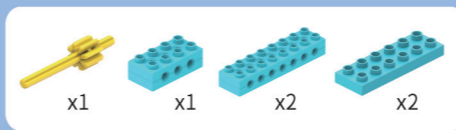

05

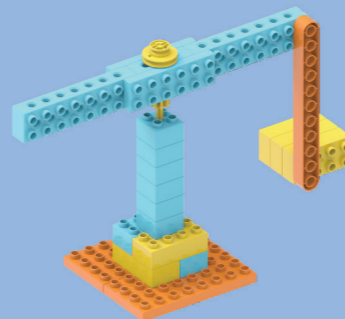
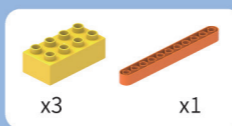

04

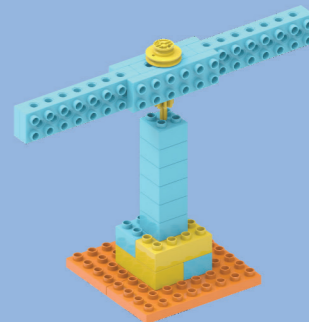

06

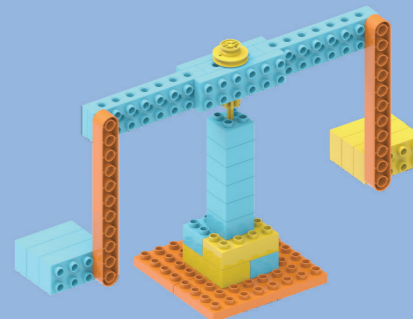
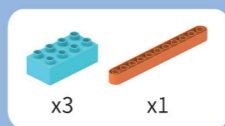

Rain Cleaner

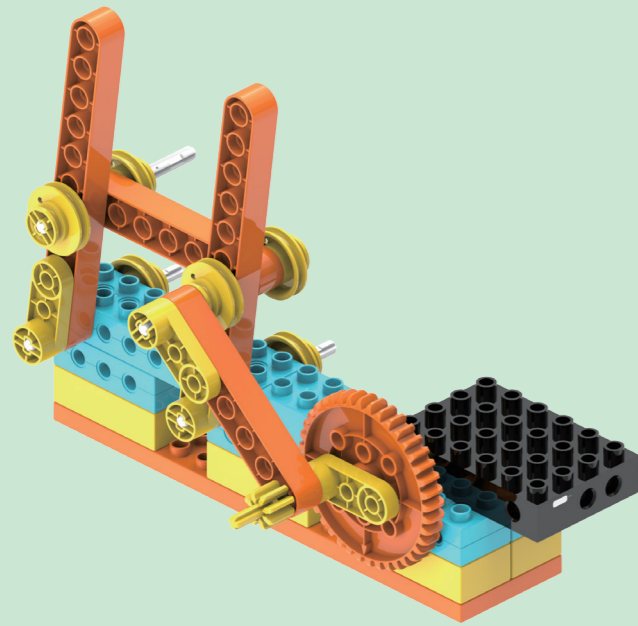

01

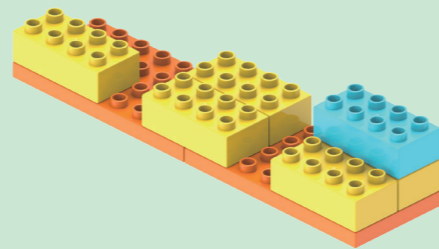
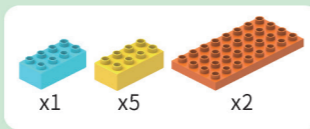

02

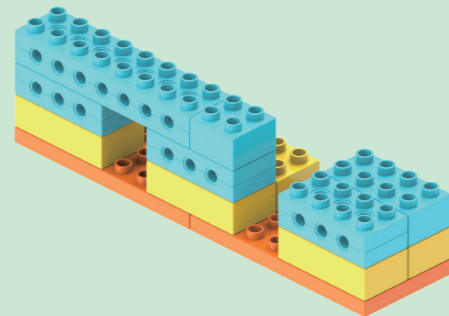
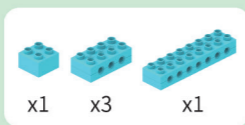

03

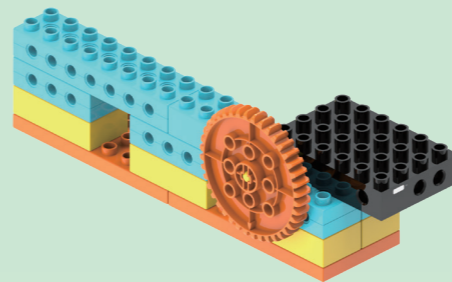
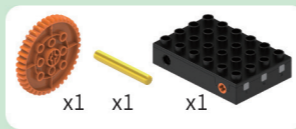

05

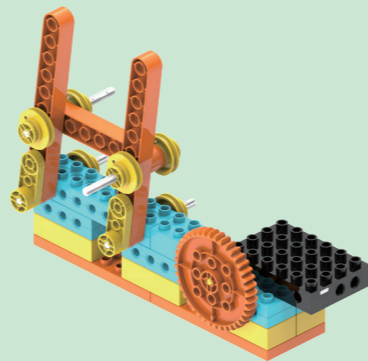
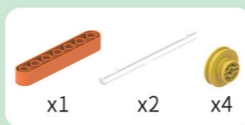

04

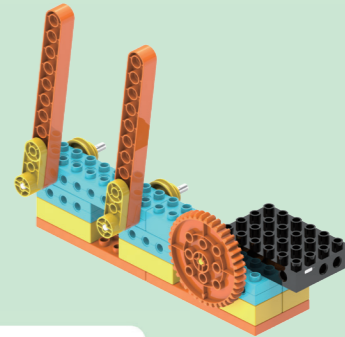

06

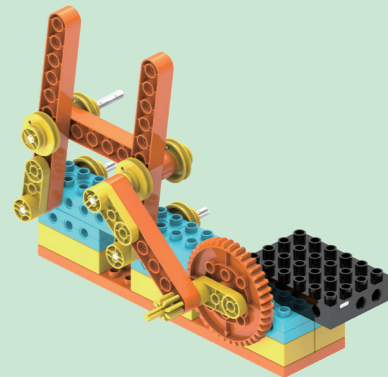
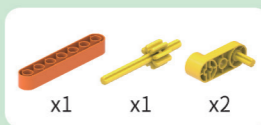

Excavator

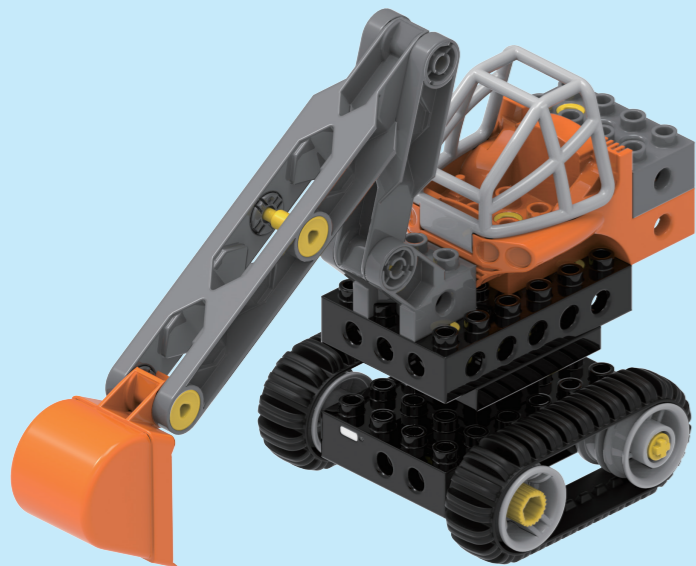

01

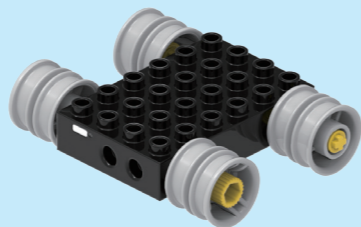
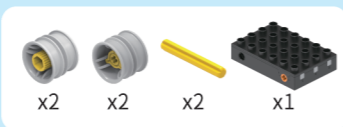

02

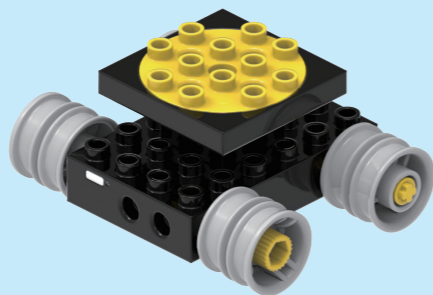

03

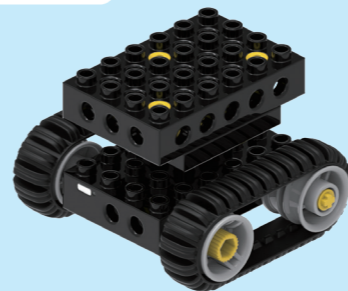

05

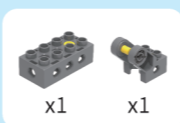

04



06

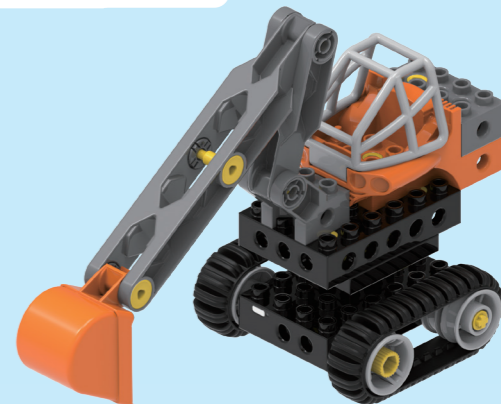
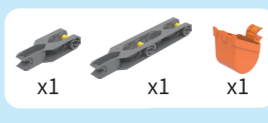

Bulldozer



01

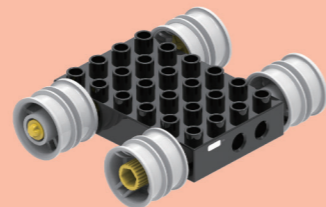

02

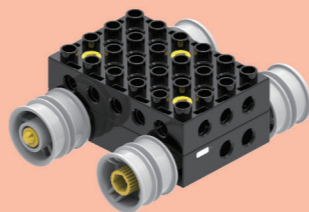

03

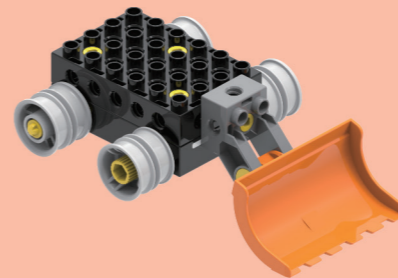

04

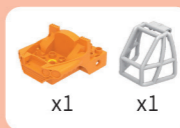

05



06



Crane

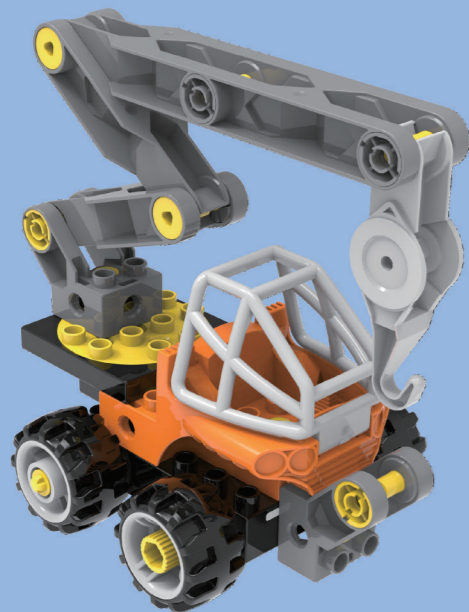

01



02

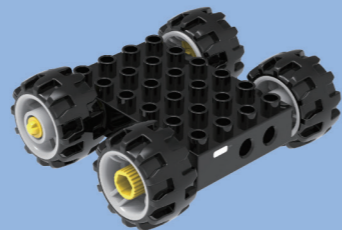

03

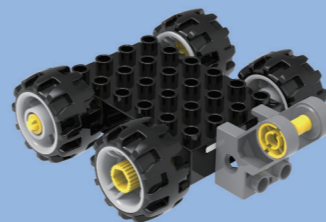

05

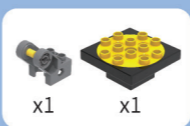

04

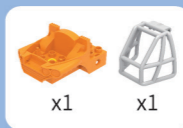

06

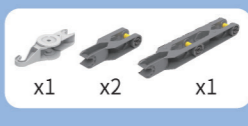

Dump Truck



01

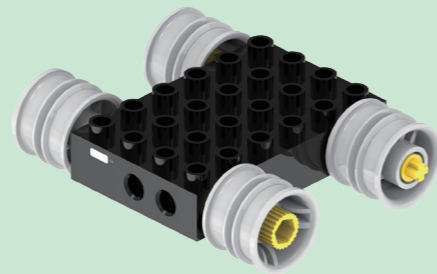

02

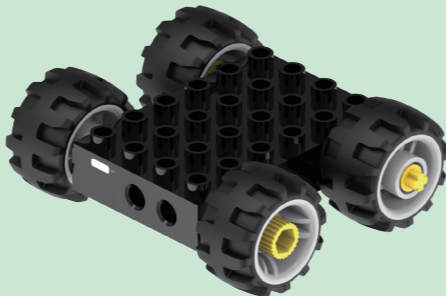

03

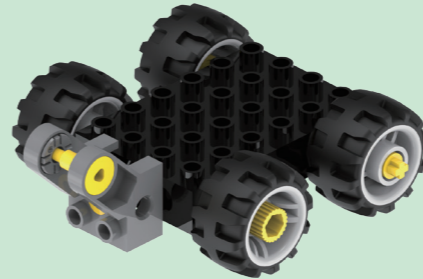

05



04

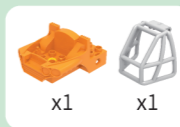

06



Steamroller

01

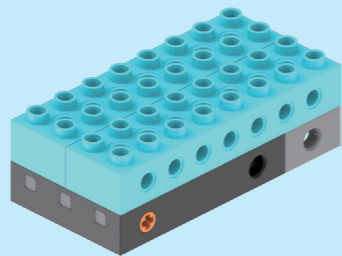
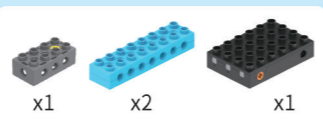

02

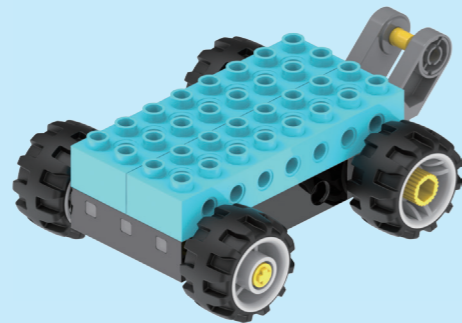

03

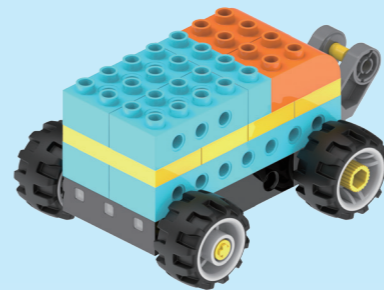
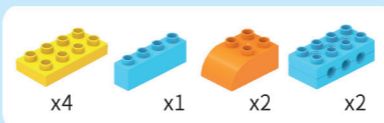

05

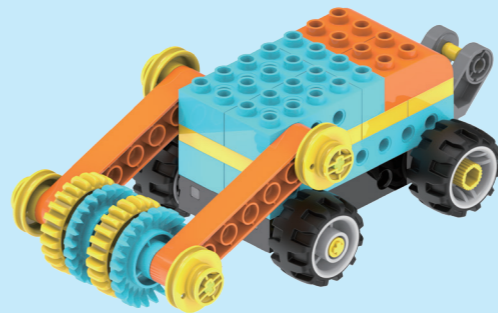

04

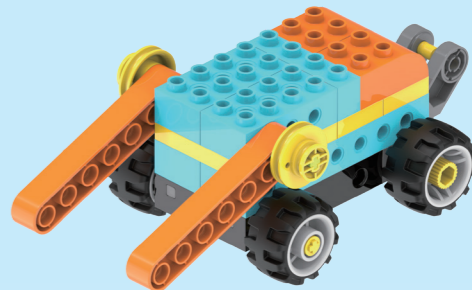
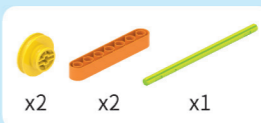

06

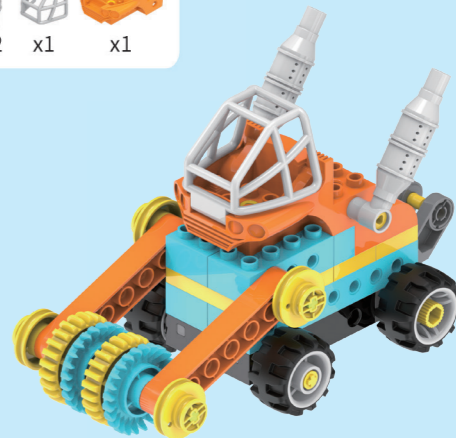

Collection Robot

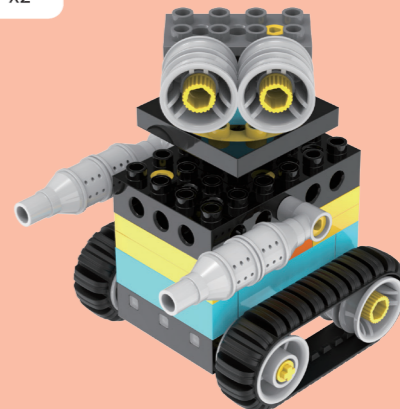
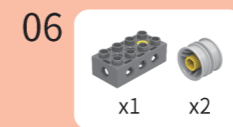
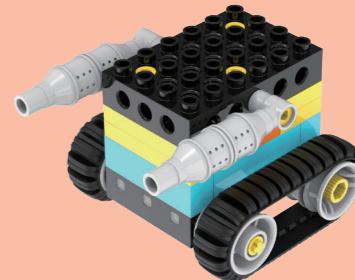
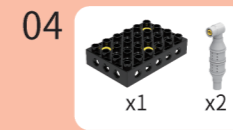
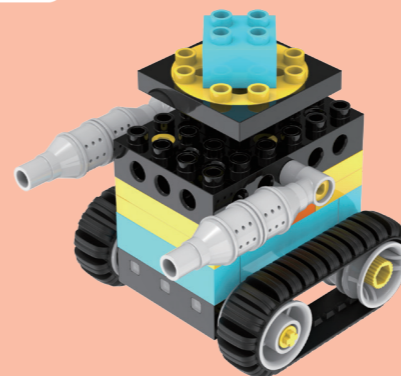
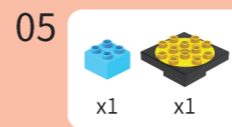
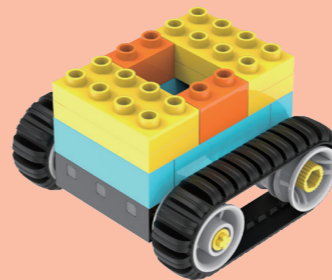
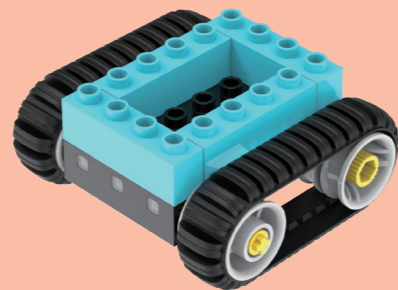
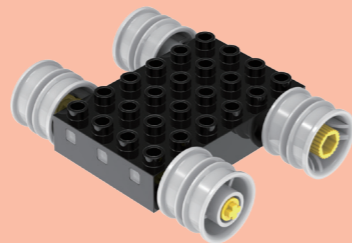
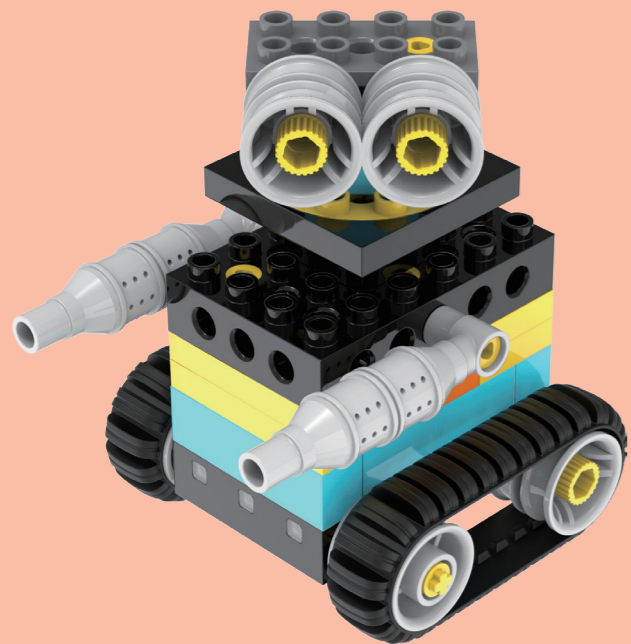

Spinning Gyroscope

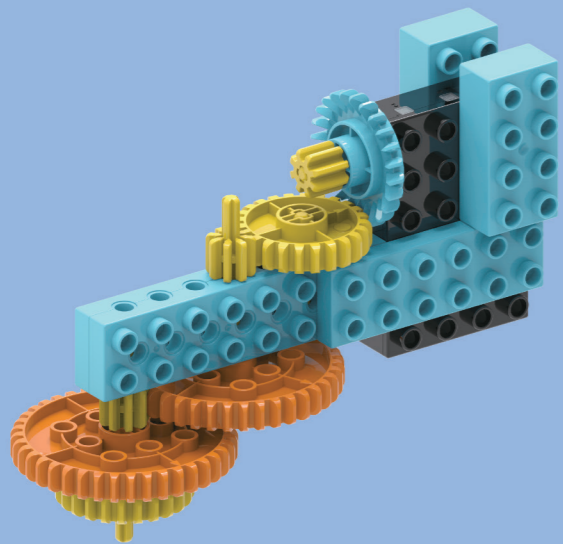

01

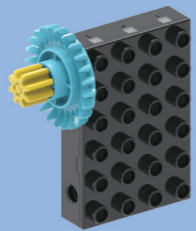
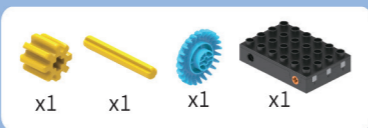

02

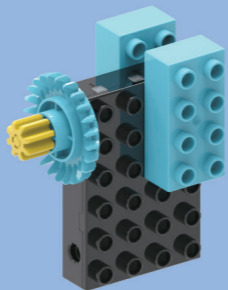

03

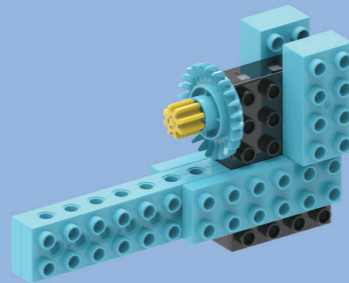
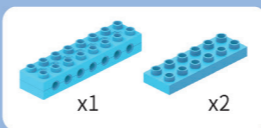

05

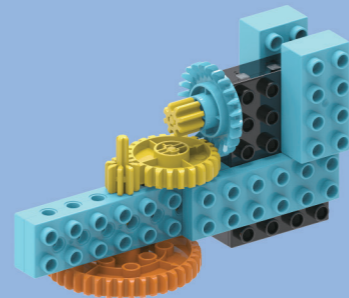
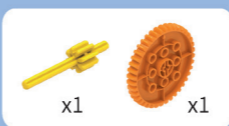

04

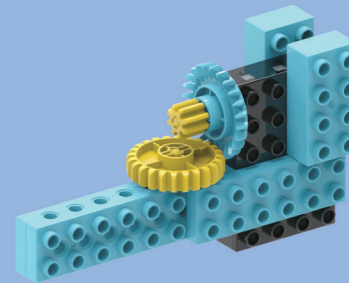
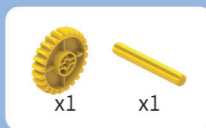

06

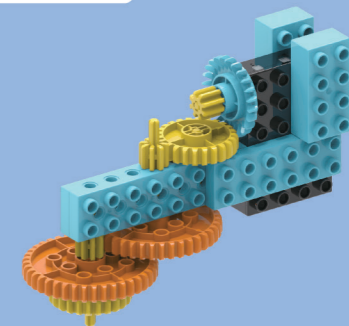
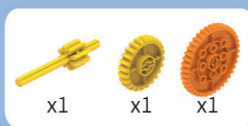

Rice Field Guardian

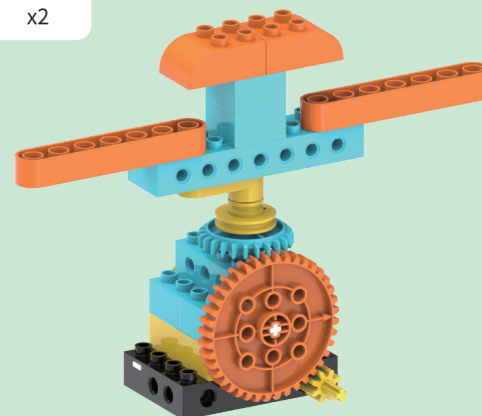
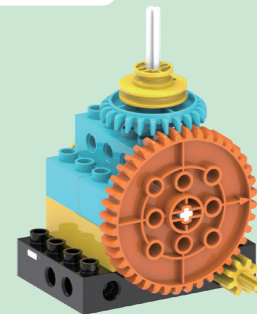
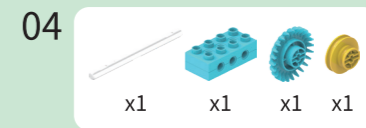
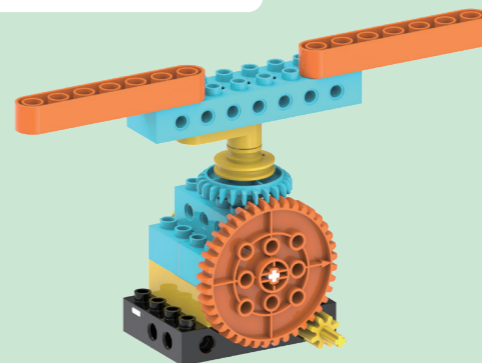
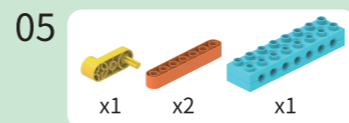
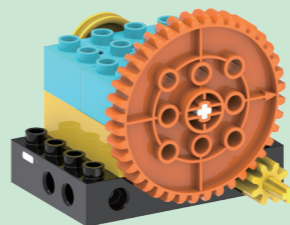
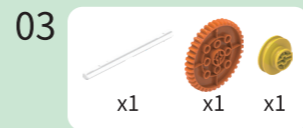
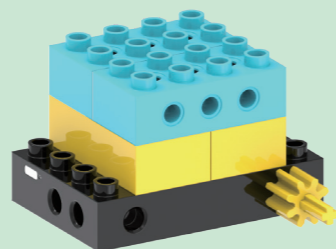
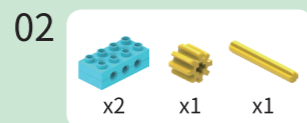
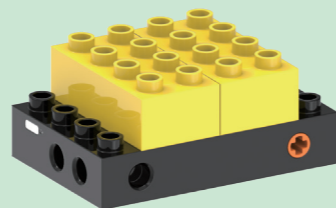
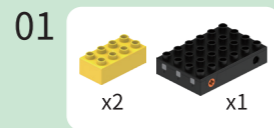
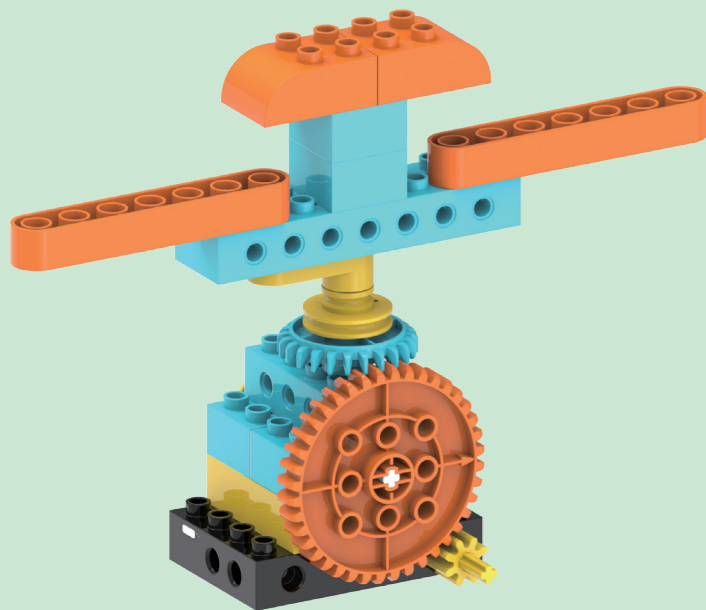

Intelligent Barrier Gate

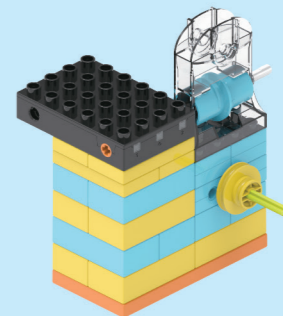
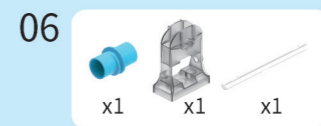
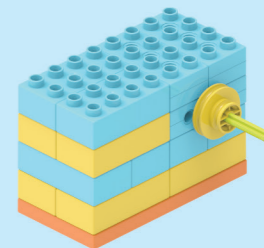
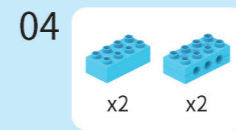
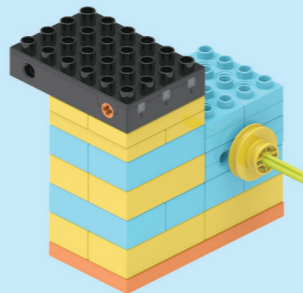
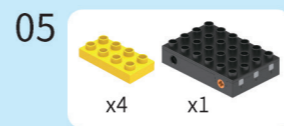
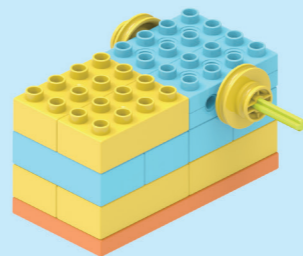
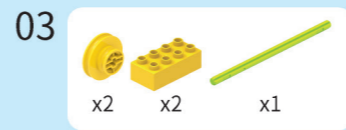
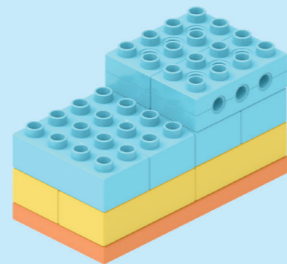
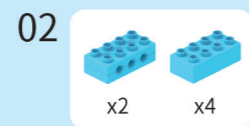
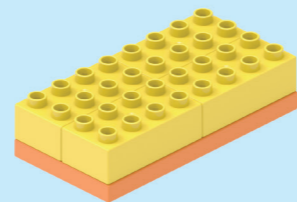
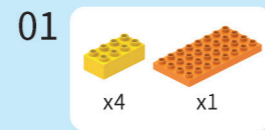
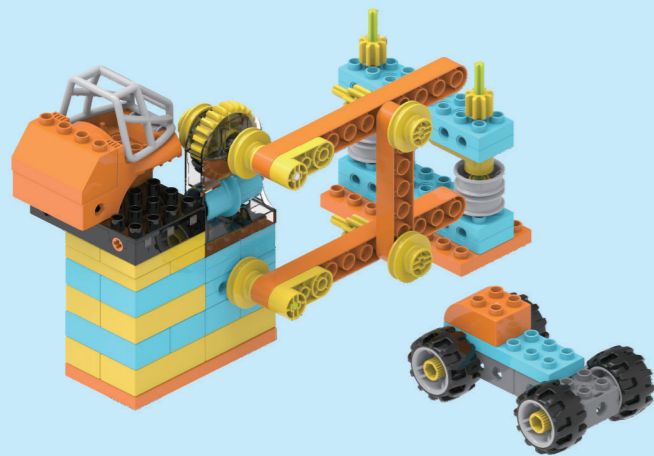

07

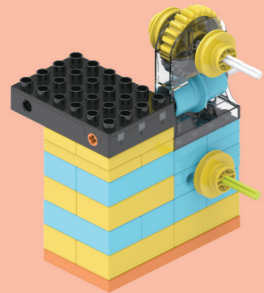
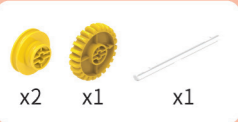

08

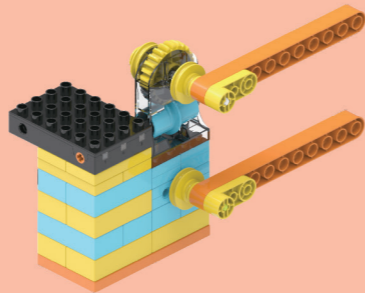
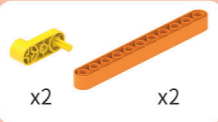

11

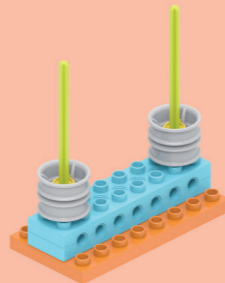
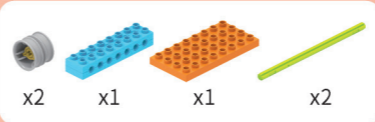

12

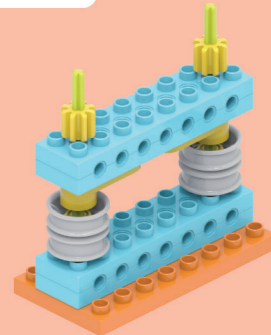
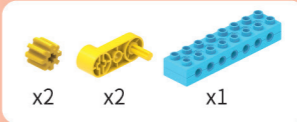

09

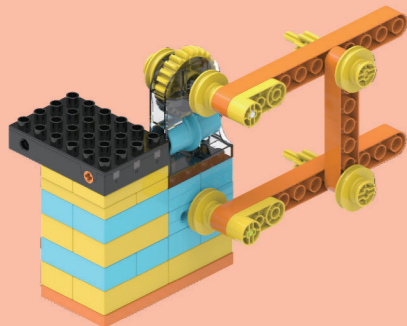
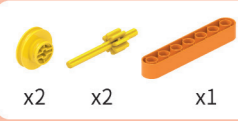

10

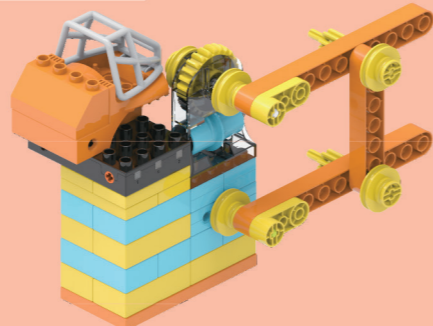

13

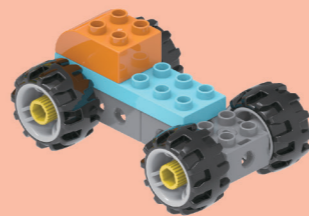

14

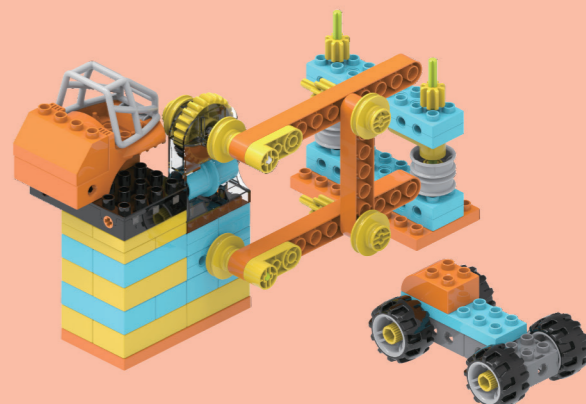

Electric Drill

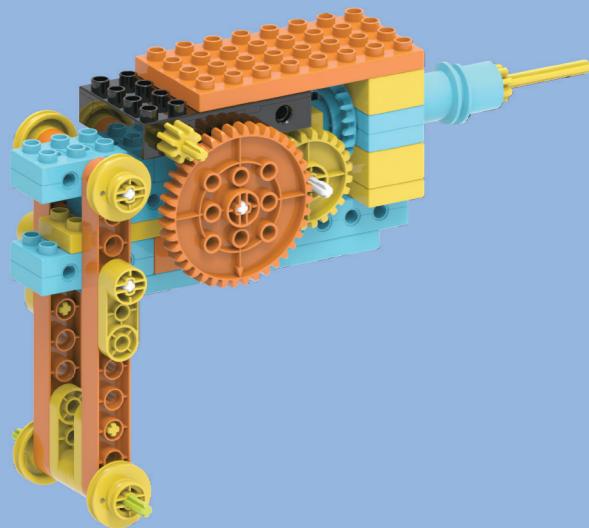

01

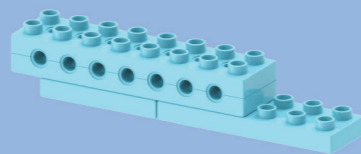
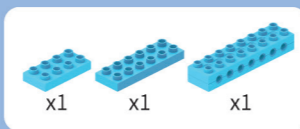

02

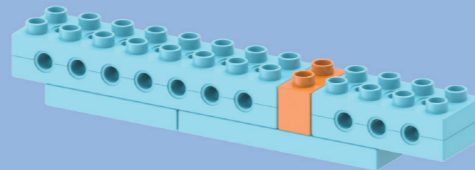
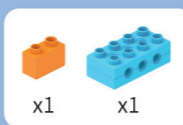

03

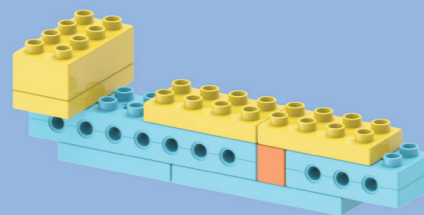
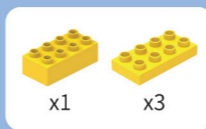

04

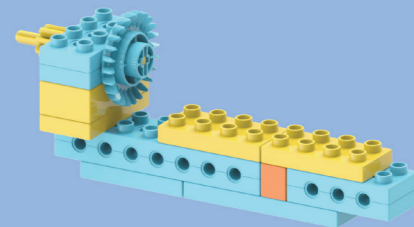
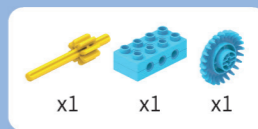

05

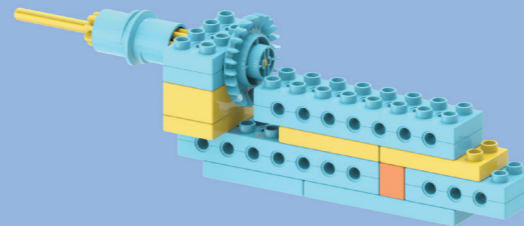
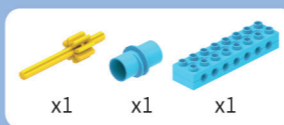

06

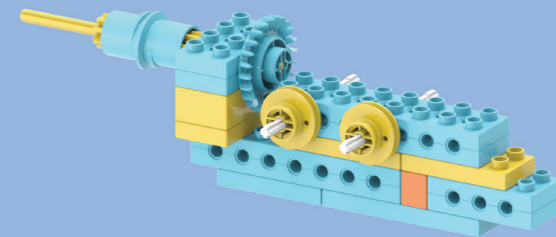
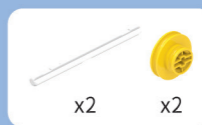

07

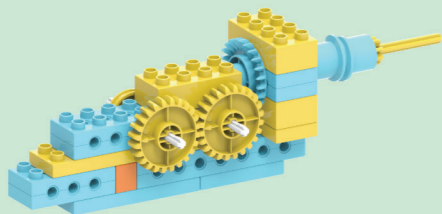
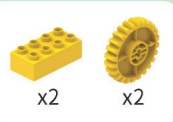

08

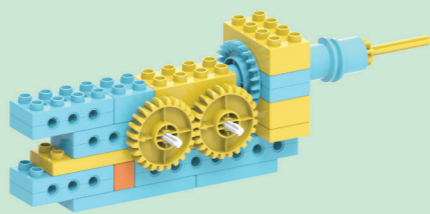
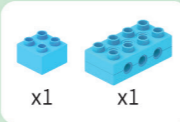

11

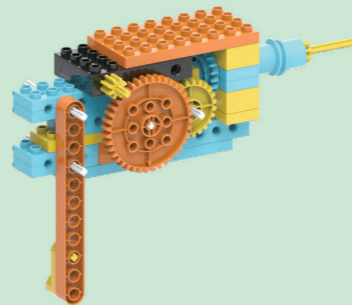

12

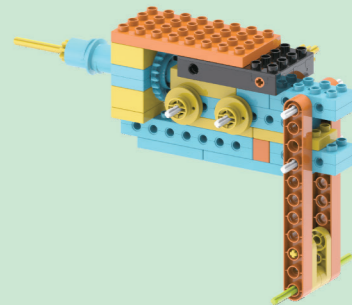
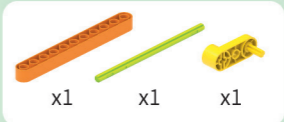

09

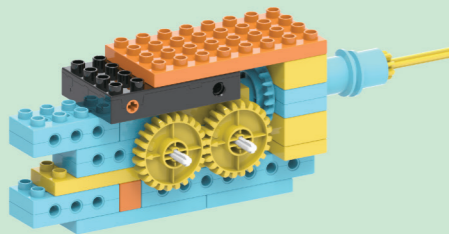
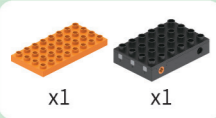

10

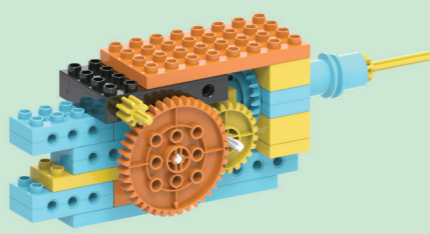
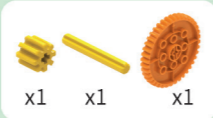

13



14

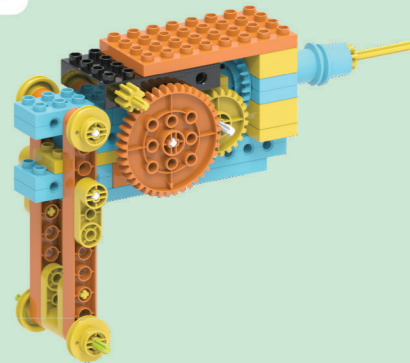

Magic Planet

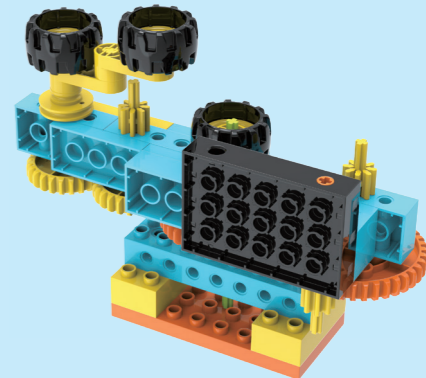
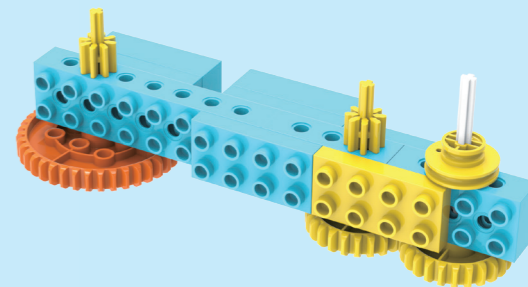
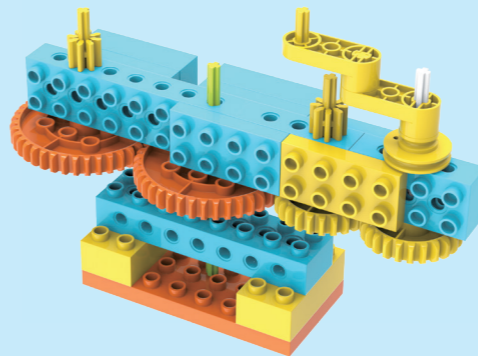
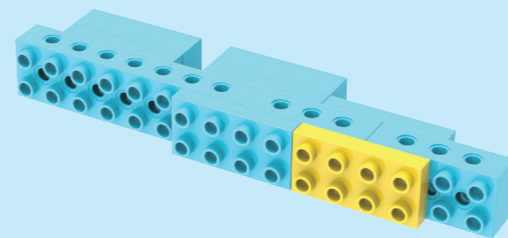
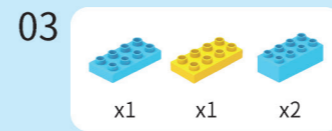
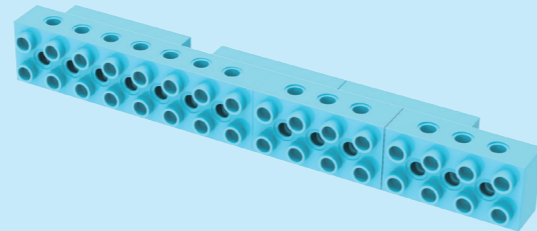
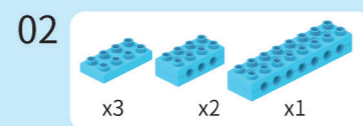
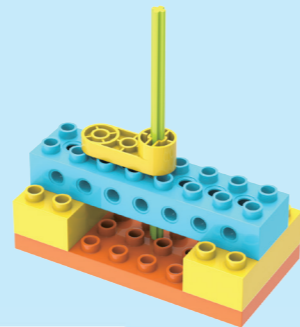
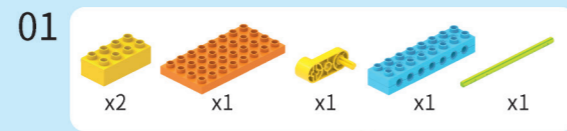
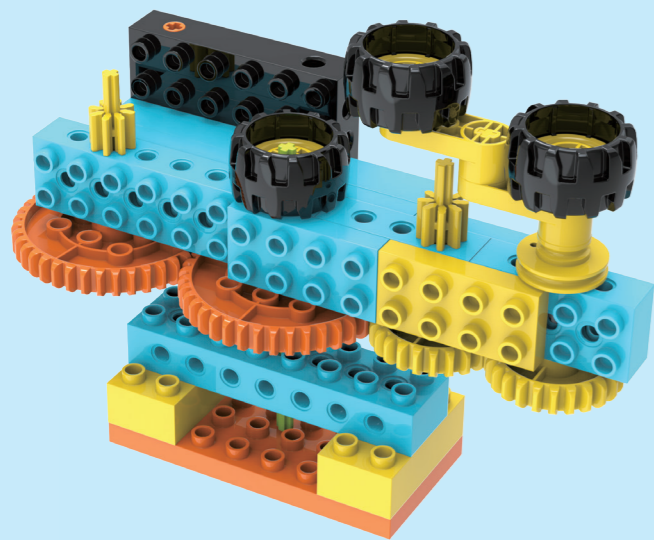

Spinning Heart

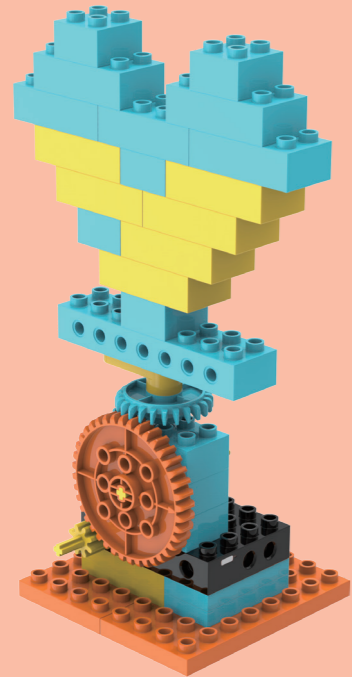

01

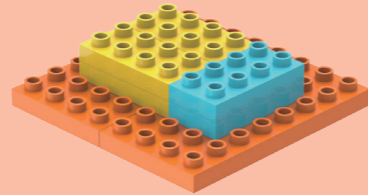
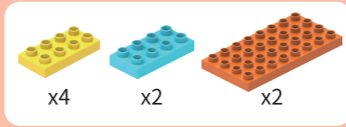

02

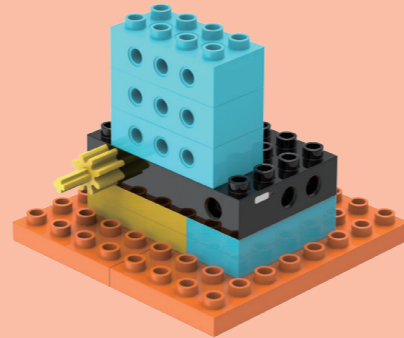
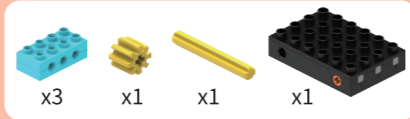

03

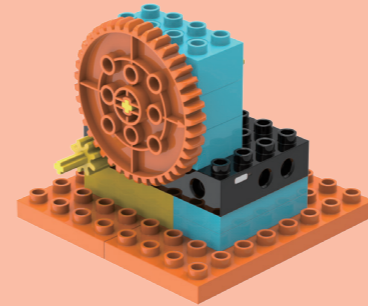
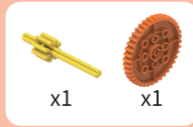

05

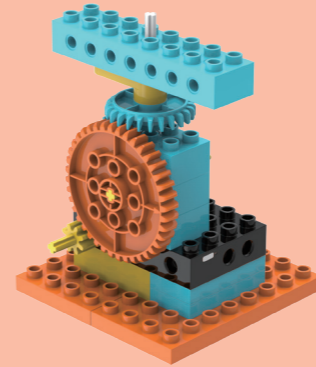
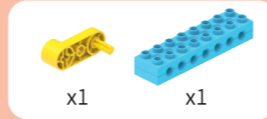

04

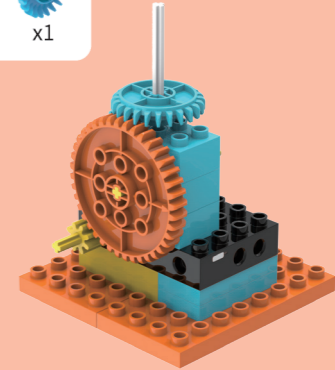
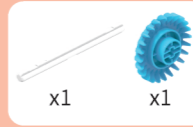

06

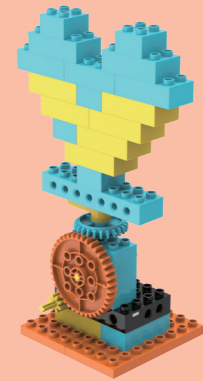
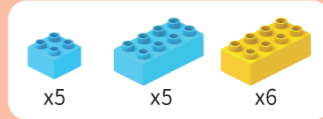

Cargo Conveyor

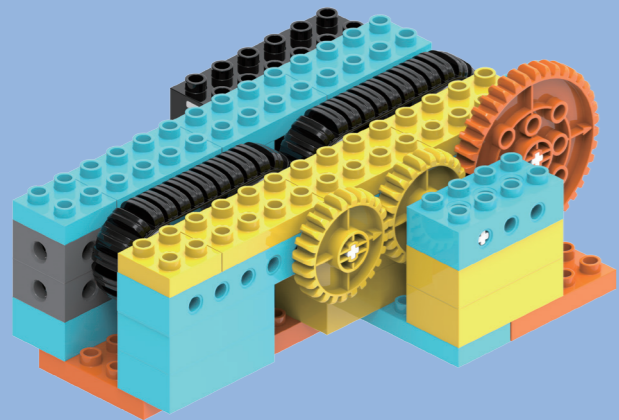

01

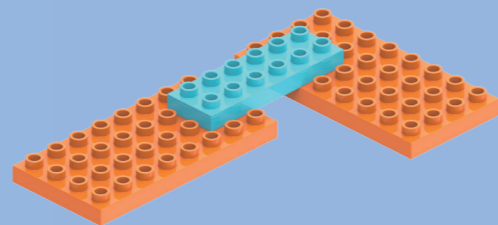
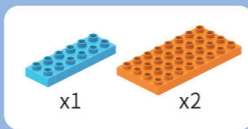

02

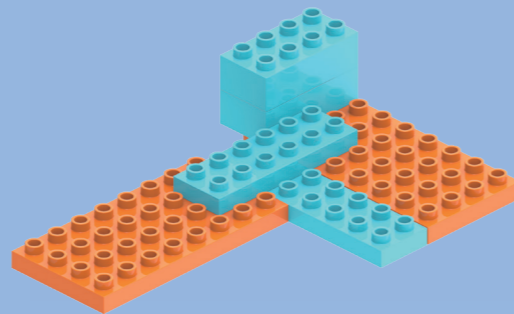
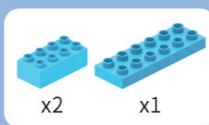

03

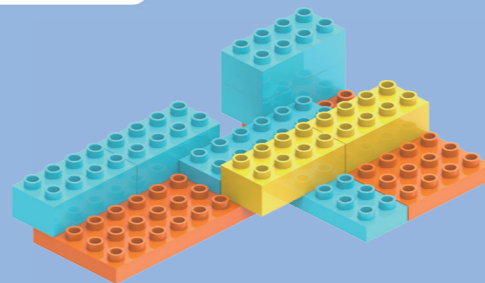
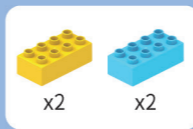

05

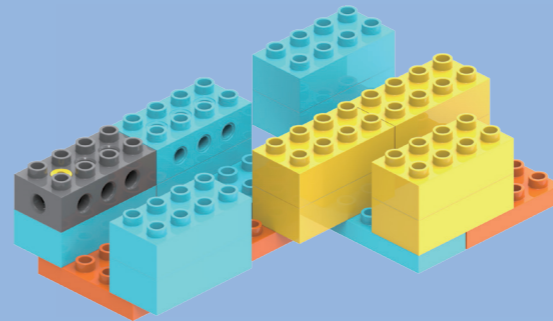

04

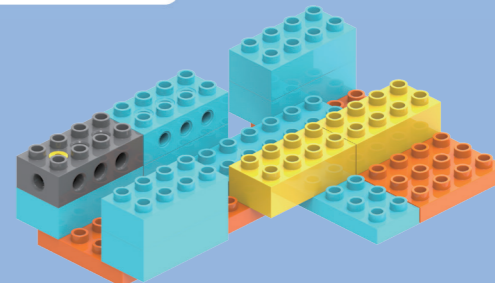
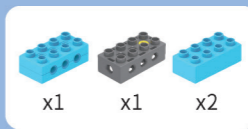

06

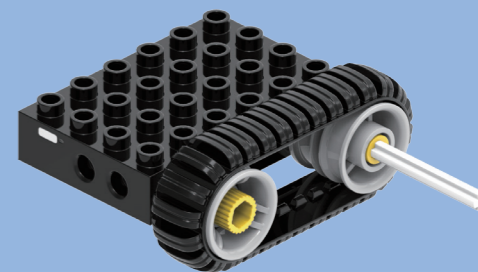

07

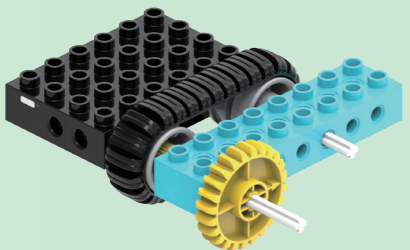
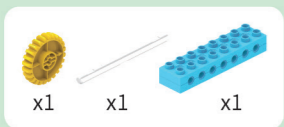

08

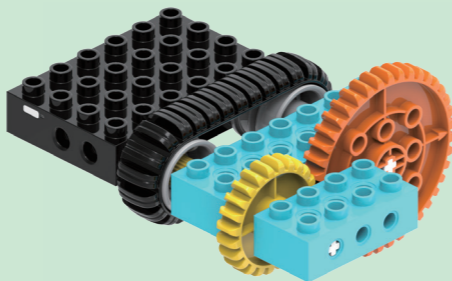
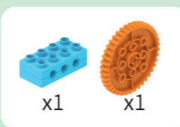

11

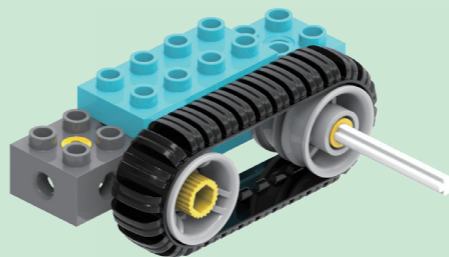

12

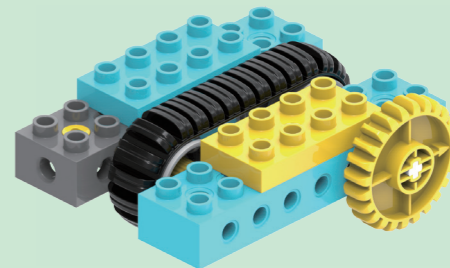
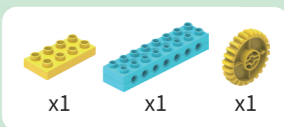

09

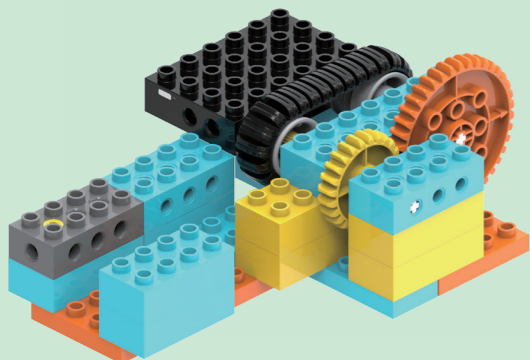

10

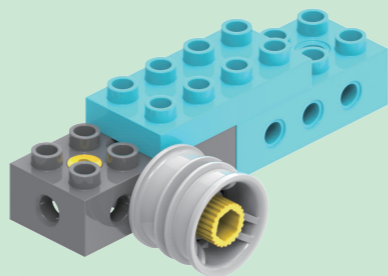
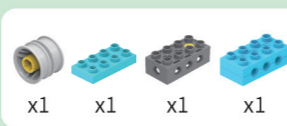

13

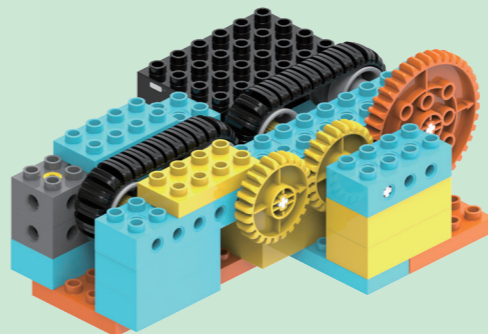

14

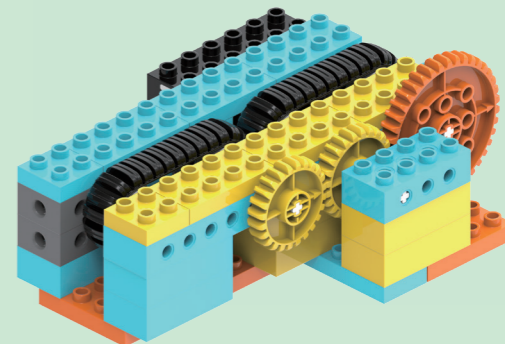
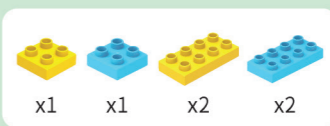

Happy Party

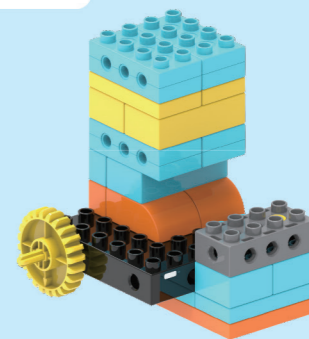
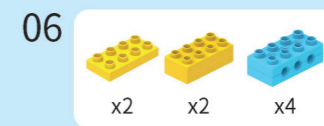
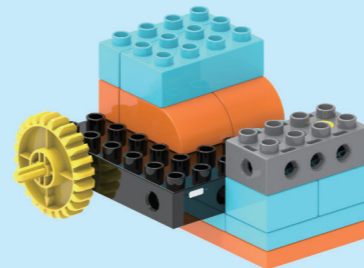
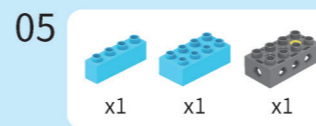
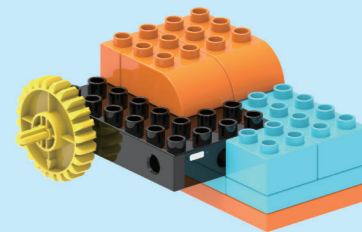
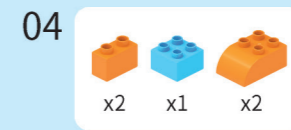
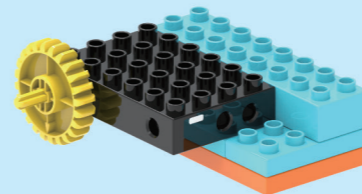
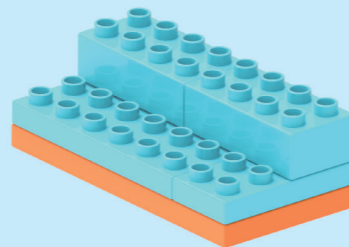
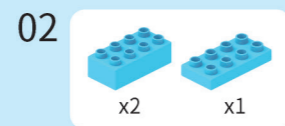
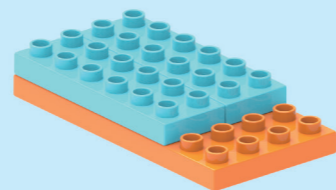
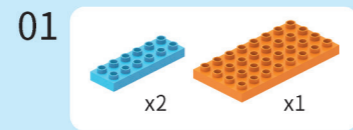
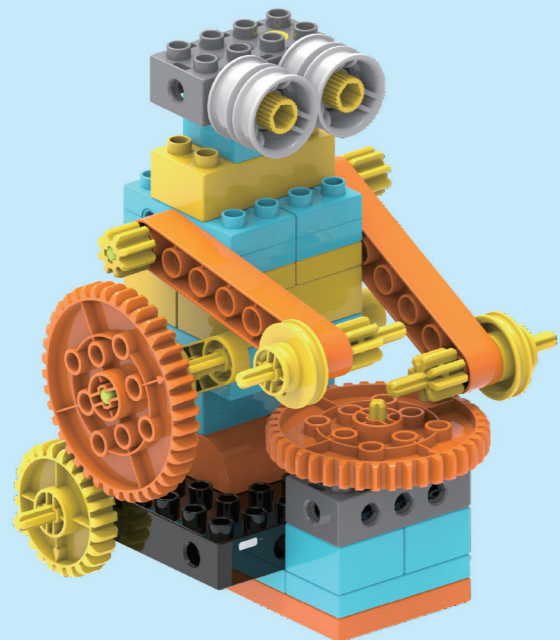

07

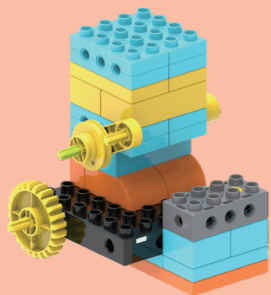
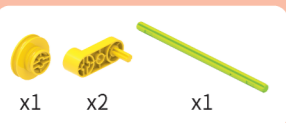

08

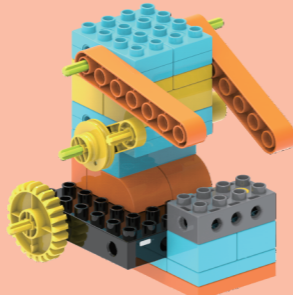
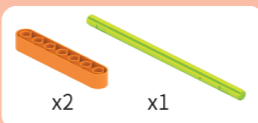

09

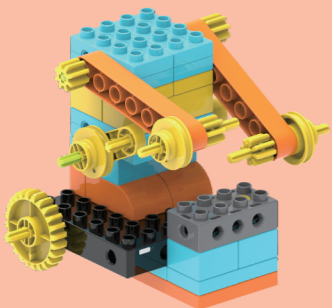

10

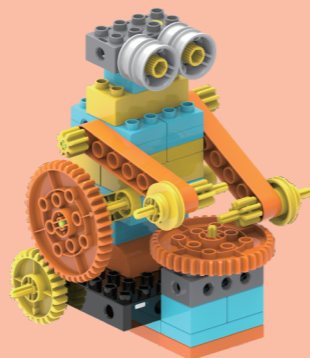
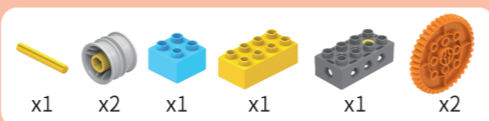

Product Name: Future Mechanic

Model Number: MKZ-OBK-EC

Suitable Age: 3 years and up

Warning! Do not aim at eyes or face.

Warning! Contains small parts, not suitable for children under 3 years old.

Warning! Contains small balls, which may pose a choking hazard. Not suitable for children under 3 years old.

- **Important:** The user manual contains important information. Please keep it for future reference.

- **Maintenance:** This product should not be submerged in water or used in damp environments. Before use, please wipe the surface with a dry cloth to remove any stains.